



100 OHM 385 RTD RANGEABLE TRANSMITTER WITH DISPLAY MODEL T81U-XTD

DESCRIPTION

The **T81U** is a field rangeable two-wire, 4-20 mA RTD transmitter designed for use with **Type 81** 1000Ω Platinum RTD Sensors. The transmitter is available in three standard ranges, or can be set for any range between -30° to 250°F (-34° to 121°C) with a minimum span of 40°F (22°C).

To adjust the **T81U**, set the DIP switches to match the desired range and use the zero and span pots to fine tune. (A high accuracy digital ohm meter and decade box are required.)

The **XTD** display option is a 3-1/2 digit LCD indicating the temperature range of the transmitter. It is factory calibrated to the transmitter output range.

FEATURES

- *Dip switch rangeable*
- *Loop calibration test signal*
- *Low cost*
- *Snap-track mounting*
- *Loop power LED indication*
- *1/2" LCD digital display, 3-1/2 digits*

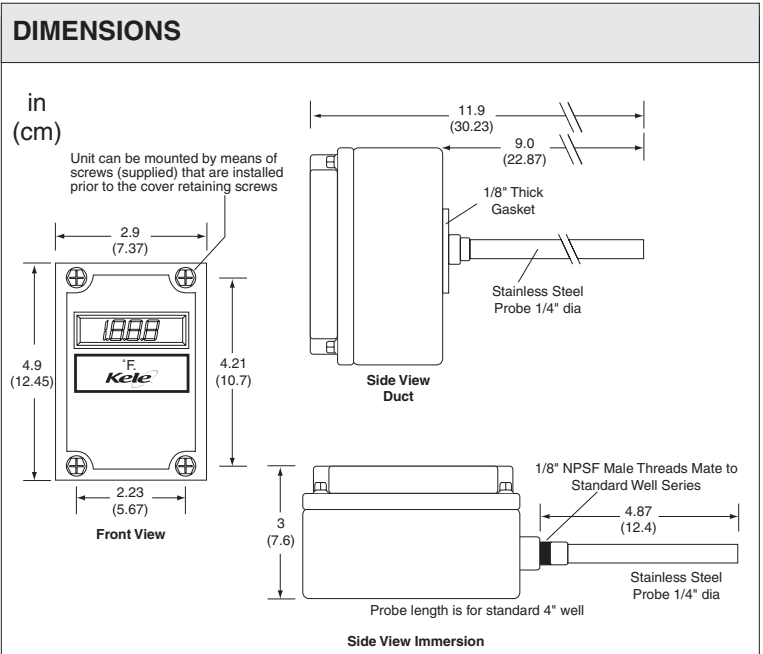
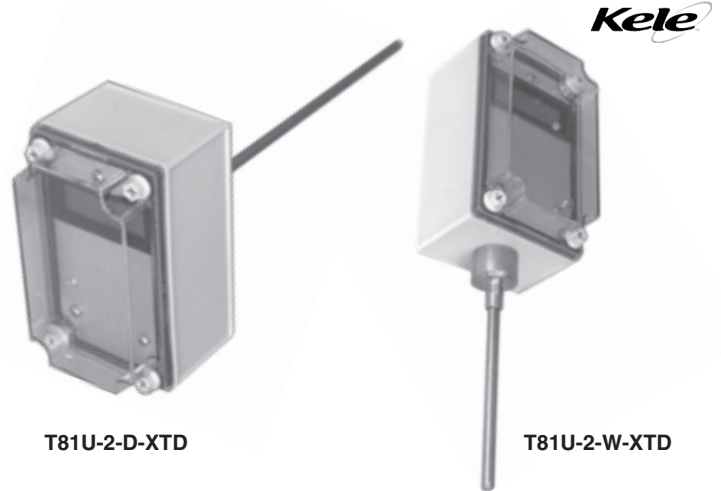

SPECIFICATIONS

Sensor input	100Ω platinum TCR 0.00385 Ω/Ω/°C	Max impedance	375Ω at 24 VDC with display
Configuration	Two-wire, loop-powered	Ambient operating temp	0° to 140°F (-18° to 60°C)
Rangeability limits T91U	-30° to 250°F (-34° to 121°C) Min span of 40°F (22°C)	Humidity	0% to 95% noncondensing
Output	4-20 mA	Accuracy	0.1°F or 0.2% of span
Display option (XTD)	3-1/2 digit LCD	Dimensions	2.9"W x 3"D x 4.9"H (7.37 x 7.6 x 12.5cm)
Output limit	25 mA (sensor leads open)	NOTE: The T81 is field rangeable. The XTD is factory calibrated only it is recommended that this unit be sent to the factory for any recalibration.	
Loop calibration output	20 mA ±0.2%		
Supply voltage	24 VDC, one power supply may power multiple units		

WIRING

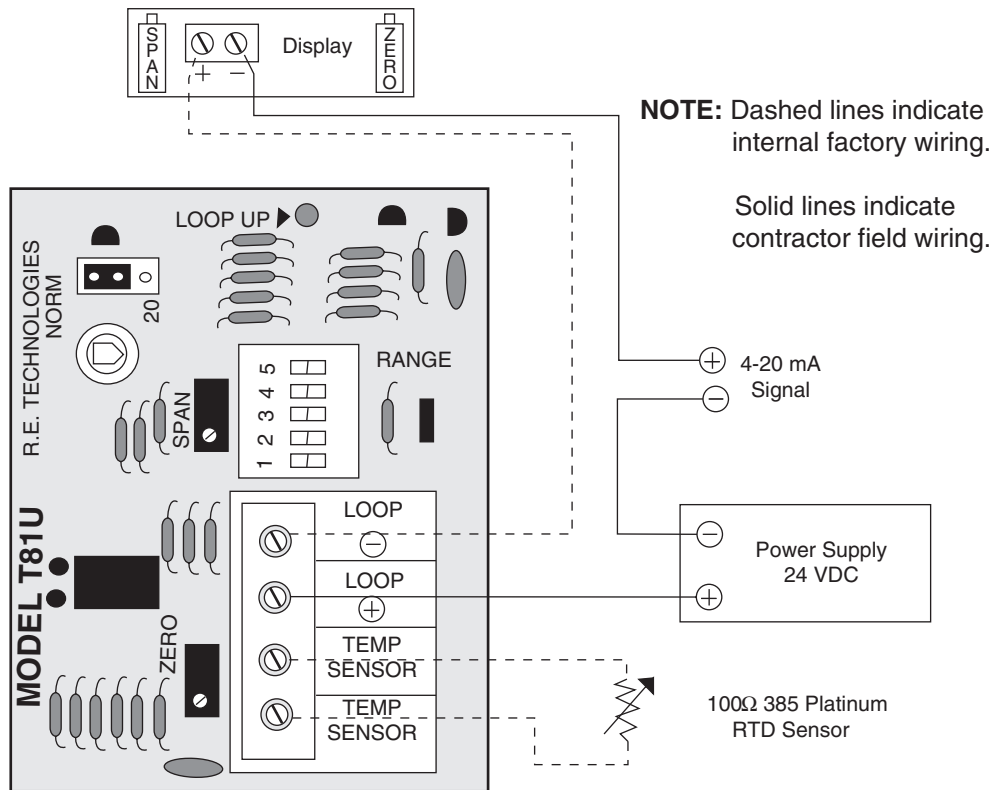

ORDERING INFORMATION

MODEL	DESCRIPTION
T81U	4-20 mA Rangeable RTD Transmitter Standard Rangeability
	RANGE
2	-20° to 140°F (-29° to 60°C)
3	0° to 100°F (-18° to 38°C)
4	30° to 240°F (-1° to 116°C)
XR†	Special range (See previous page for rangeability limits)
	SENSOR TYPE
D	ST-D81-XW Duct Sensor*
W	ST-W81-XW Immersion Sensor* with well
XTD**	Digital display option for (D) Duct or (W) immersion sensors

T81U - **2** - **D** - **XTD** *Example: T81U-2-D-XTD Transmitter with range of -20° to 140°F (-29° to 60°C) mounted and wired in duct sensor with display*

†Indicate at time of order

*Includes sensor mounted and wired

** Engineering plate is in Deg F. If Deg C is needed, indicated at time of order.