

data SHEET

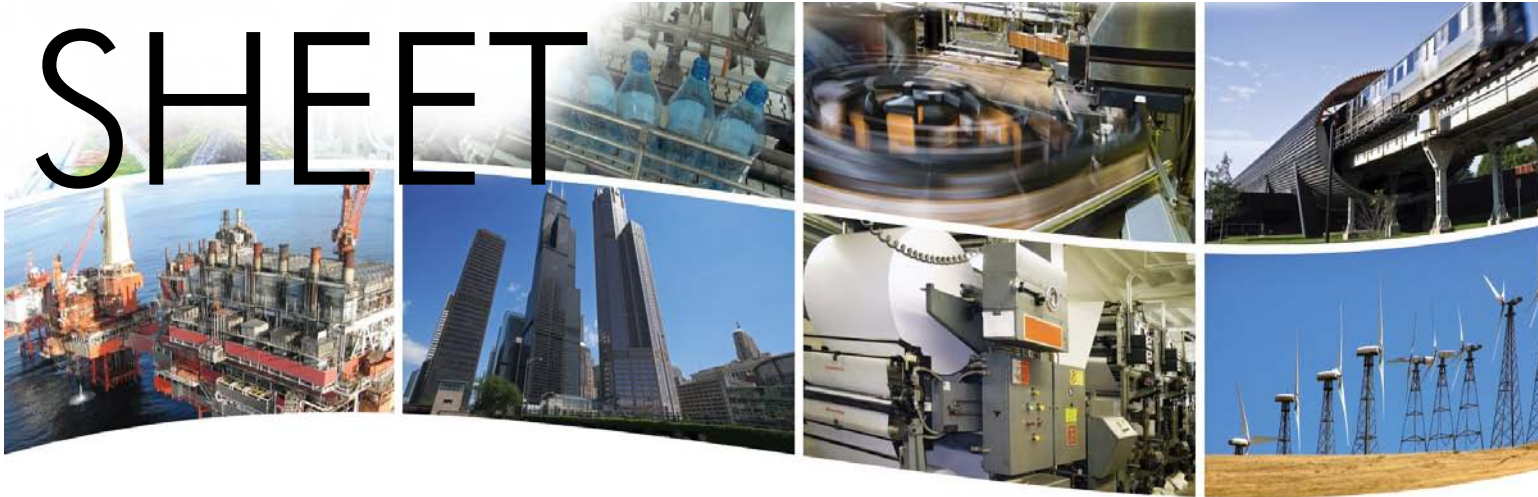

5-Port BAS Switch Ethernet Built for Buildings

An expanding need exists for Ethernet switches in many Building Automation Systems (BAS). The 5-port Plug-and-Play (PnP) BAS Switch is ideal for low-cost 10/100 Mbps Ethernet switching applications where equipment is mounted in shallow-depth control cabinets.

No configuration is needed. Each port automatically sets its data rate and duplex using the Auto-negotiation protocol. Communication matches the capability of the link partner: either 10 Mbps or 100 Mbps and either half- or full-duplex. Each port adapts to either a straight-through or crossover cable using the Auto-MDIX protocol. There is no need to stock crossover cables for switch-to-switch cabling.

Each unit is housed in a rugged metal enclosure and can be either panel or DIN-rail mounted. A writable label allows listing the location of field devices connected to each port.

The half-wave rectified low-voltage power supply allows sharing 24 VAC/VDC with other devices. LEDs for data rate and activity aid in troubleshooting.

Unlike office-grade Ethernet equipment which is not adaptable to control panels, the BAS Switch makes an Ethernet installation neat, professional, and dependable.

Simple to Install and Use ...

- DIN-rail and panel-mountable versions
- Auto-MDIX and auto-negotiated communication
- Industrial temperatures: 0°C to +60°C
- 10BASE-T/100BASE-TX compliant
- Industrial environment EMC compatible
- UL 508 Listed, Industrial Control Equipment
- CE Mark and RoHS compliant
- Diagnostic LEDs
- 10–36 VDC and 24 VAC ($\pm 10\%$) 47–63 Hz
- Power through a quick-disconnect terminal strip
- Writable label for listing connected devices



CTRLink®

Mechanical Drawings

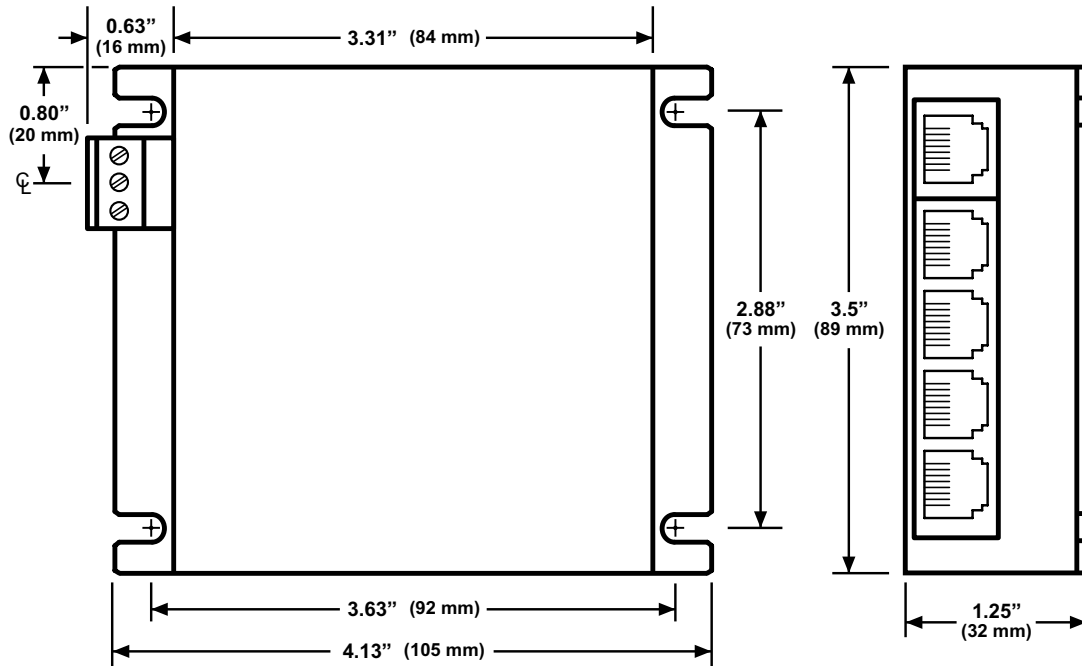

EIBA5-100T Panel Mount

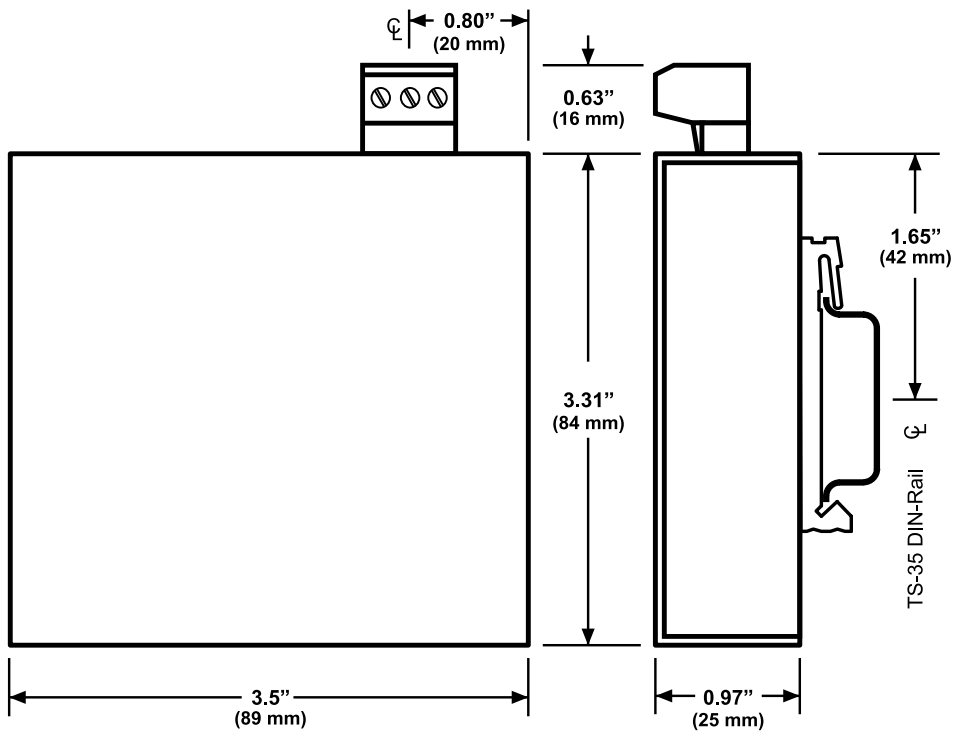

EIBA5-100T/R Din-rail Mount

Specifications

Power Requirements	10–36 VDC 3 W or 24 VAC ±10% 6 VA 47–63 Hz
Operating Temperature	0°C to 60°C
Storage Temperature	–40°C to 85°C
Relative Humidity	10–95%, non-condensing
Protection	IP30
Mounting	TS-35 DIN-rail
Shipping Weight	1 lb (0.45 kg)
Ethernet Communications	IEEE 802.3 10/100 Mbps data rate using RJ-45 connectors, 100 m (max)
LEDs	Power Green = power OK Port LEDs Green = 100 Mbps communication established Yellow = 10 Mbps communication established Flashing = data transmissions occurring
Regulatory Compliance	CE Mark; CFR 47, Part 15 Class A; RoHS; UL 508 Industrial Control Equipment



RJ-45 Connector Pin Assignments

Pin	Function
1	TD+
2	TD–
3	RD+
4	Not Used
5	Not Used
6	RD–
7	Not Used
8	Not Used

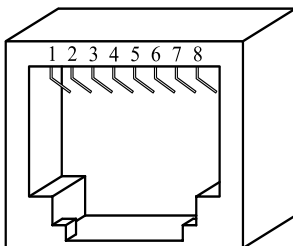

Power Considerations

Applied voltage must be in the specified range and deliver a current commensurate with power consumption. The recommended size for solid power conductors is 16–20 AWG; and for stranded conductors use 16–18 AWG. Zero volts (COM) is isolated from chassis (earth). Input connections are reverse-polarity protected.

Connecting chassis to earth or using a backup source is always optional.

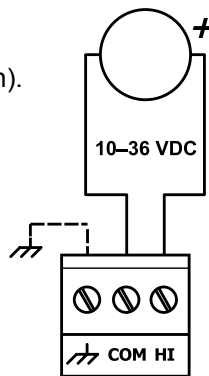

DC Powered

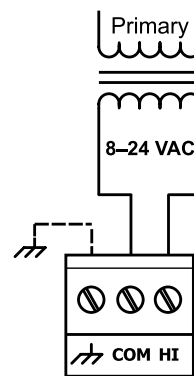

AC Powered

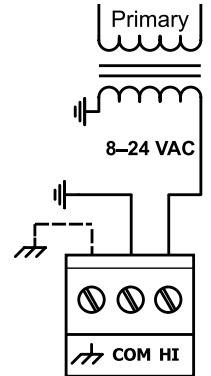

AC Powered with Grounded Secondary

Typical Switch Installations

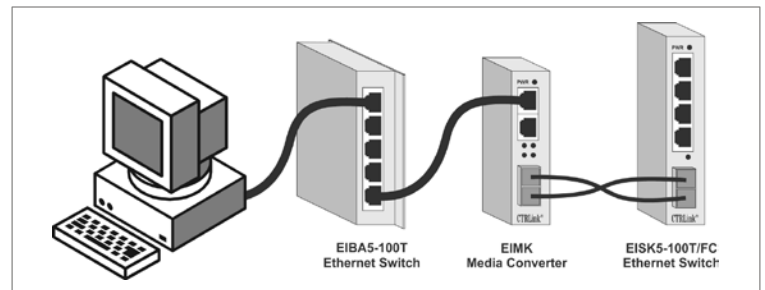
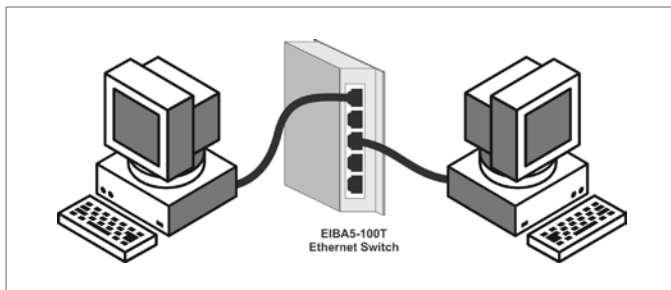

Ordering Information

Model	Description
EIBA5-100T	Five-port 10BASE-T/100BASE-TX switching hub, panel mount
EIBA5-100T/R	Five-port 10BASE-T/100BASE-TX switching hub, DIN-rail mount

Accessories

Model	Description
AI-XFMR	Wall-mount plug-in transformer, 120 VAC input/24 VAC output (nominal values)
AI-XFMR-E	Wall-mount plug-in transformer, 230 VAC input/24 VAC output (nominal values)

United States

Contemporary Control Systems, Inc.
2431 Curtiss Street
Downers Grove, IL 60515
USA

Tel: +1 630 963 7070
Fax: +1 630 963 0109

info@ccontrols.com
www.ccontrols.com

China

Contemporary Controls (Suzhou) Co. Ltd
11 Huoju Road
Science & Technology Industrial Park
New District, Suzhou
PR China 215009

Tel: +86 512 68095866
Fax: +86 512 68093760

info@ccontrols.com.cn
www.ccontrols.asia

United Kingdom

Contemporary Controls Ltd
14 Bow Court
Fletcher Gate
Coventry CV5 6SP
United Kingdom

Tel: +44 (0)24 7641 3786
Fax: +44 (0)24 7641 3923

info@ccontrols.co.uk
www.ccontrols.eu

Germany

Contemporary Controls GmbH
Fuggerstraße 1 B
04158 Leipzig
Germany

Tel: +49 341 520359 0
Fax: +49 341 520359 16

info@ccontrols.de
www.ccontrols.eu