



Honeywell Fixed Gas Detection Calibration Handbook

General Calibration Notes	7
Zero Calibrations	7
Bump Test	7
Span Calibration	7
4-20mA Output Adjustment	7
VA201T / VA201M	
VA201T/VA201M Calibration Procedure.....	10
VA301D2 / GasPoint II	
VA301D2/GasPoint II Calibration Procedure	15
301IRFS / S301D2 with VA301EM	
301IRFS / S301D2 with VA301EM Calibration Procedure.....	21
VA301M / S301M	
VA301M Calibration Procedure	27
S301M Calibration Procedure.....	28
VA301W Wireless Transmitter	
301W Calibration Procedure.....	33
705 / Sensepoint Combustible	
705 Sensor and Sensepoint Combustible	37
90DM4	
90DM4 Calibration Procedure.....	41
Connecting the Hardware	41
Adjusting the Zero (units without display)	41
Adjusting the Zero (units with display)	41
Apex Transmitter and Sensor	
Apex Calibration Procedure	45
E³Point	
E ³ Point Calibration Procedure.....	51
Set Zero Menu	51
Set Span Menu	51
Manning EC-F2	
EC-F2 Calibration Procedure.....	55
Manning EC-F3-O2	
EC-F3-O2 Calibration Procedure.....	59
Manning EC-F9-NH3	
EC-F9-NH3 Calibration Procedure	63
Manning EC-P2	
EC-P2 Calibration Procedure.....	67

Searchline Excel

Unit Alignment and Zero Cal with XNX.....	71
Zero Calibration	74
Unit Alignment and Zero Cal with SHC-1 Handheld Interrogator.....	75
Zero Calibration	82

IAQPoint

IAQPoint Calibration Procedure	85
Setting the Sensor Zero.....	85
Calibrating the CO ₂ Sensor.....	85

IAQPoint2

IAQPoint2 Calibration Procedure	89
Calibrating the CO ₂ Sensor.....	89
Calibrating the VOC Sensor.....	90
Calibrating the Temperature Sensor	90
Calibrating the Humidity Sensor	90
Calibrating mA Output	91

IR-F9 / AirScan iR

IR-F9-RXX/AirScan iR Calibration Procedure	95
--	----

Midas® Gas Detector

Midas Calibration Procedure	99
Zero Calibration - Hardware Setup	99
Zero Calibration	99
Bump Test/Calibration Setup	100
Span Calibration	101
Flow Calibration	102

Searchpoint Optima Plus

Searchpoint Optima Plus Calibration Procedure	107
Searchpoint Optima Plus with XNX	107
Searchpoint Optima Plus with SHC-1 Handheld Interrogator.....	109

Series 3000 XPIS

Series 3000 XPIS Calibration Procedure	115
Zero and Span Calibration.....	115
Zero and Span Calibration of Hydrogen Sulfide sensors.....	118

Sensepoint Toxic

Sensepoint Toxic Calibration Procedure	121
--	-----

SQN8x

SQN8x Calibration Procedure	127
Zero Calibration - Option 1 Configuration	127
Zero Calibration - Option 2 Configuration	128
Span Calibration - Option 1 Configuration	129
Span Calibration - Option 2 Configuration	130
Span Calibration - Option 3 Configuration	131

Sensepoint XCD

Sensepoint XCD Calibration	135
Zero and Span	135
Zero Calibration	136
Span Calibration	137
Zero and Span Calibration of Hydrogen Sulfide sensors	138

Sensepoint XCD-RTD

Sensepoint XCD-RTD Calibration Procedure	141
Zero Calibration	142
Span Calibration	143

XNX Universal Transmitter

XNX Calibration Procedure	147
Zero and Span Calibration for XNX	148
Zero Calibration	148
Span Calibration	149
Using the Calibration Cup	150
Zero and Span Calibration of XNX EC Hydrogen Sulfide (H ₂ S) Sensors	150
Zero and Span Cal for XNX with MPD / 705 Comb / Sensepoint Comb	151
Zero Calibration	151
Span Calibration	152

Calibration Kits and Equipment

Calibration Kits and Equipment	157
---	------------

General Calibration Notes

When calibrating a detector...

- **ALWAYS** refer to the product manual first!
- **YOU MUST** use the proper Calibration Cap when calibrating
- **NEVER** use the Weather Protection Housing or other accessories for calibration – use for Bump Test only
- **YOU MUST** use the proper flow rate for the sensor type used in the transmitter

Zero Calibrations

Zero calibration is a recommended procedure that should be performed periodically to improve the performance of the sensor. This is particularly important when the sensor is operating outside of normal environmental conditions.

- **ALWAYS** use Zero Air calibration gas or reference device (such as a calibrated portable) when doing Zero Calibrations

Bump Test

A bump test is not intended to be an accurate calibration, but is used as a confidence check to ensure that the gas detection system is functional. Some of the target gases are difficult to handle therefore bump testing often makes use of cross sensitivities so that more convenient gases can be utilized.

- The bump test is a functional check only.
- Consult your local guidelines and/or product manual for recommended best practices

Span Calibration

Bump test versus calibration

Factory calibration is performed in a controlled environment with certified reference devices providing a high level of accuracy. Field span calibrations are subject to external influences such as background concentrations of gas and airborne contaminants that may affect the accuracy of a field calibration.

- **ALWAYS** use the target gas for calibrations when possible otherwise contact the manufacture for approve Cross-Calibration gas and predicted response to concentration (some gases can damage sensors)

Most products are calibrated to 50% FSD (Full Scale) while others may require other values – refer to product manuals or contact the manufacture for details.

4-20mA Output Adjustment

- It may be required to adjust the 4-20 mA output based on the installation. See the respective product manual for specifics.



VA201T / VA201M

VA201T/VA201M Calibration Procedure

IF YOUR TRANSMITTER WAS PURCHASED BEFORE APRIL 1, 2004, CONTACT TECHNICAL SUPPORT LINE AT 1-800-563-2967

1. Warm-Up Period

Turn the unit on for a minimum of five (5) minutes when battery back-up sensor board is included.

Check Calibration Information table for specific warm-up time.

2. Connecting the Hardware

Plug the voltmeter probes in the unit and adjust it to read VDC.

Plug the calibration adaptor into the gas sensor inlet.

Always plug the calibration adaptor to have the holes in a vertical position.

Always connect the tubing in the lower hole.

Screw the regulator to the calibration span gas cylinder.

Connect the regulator outlet to the calibration adaptor with the 1/8 I.D. polymer tubing.

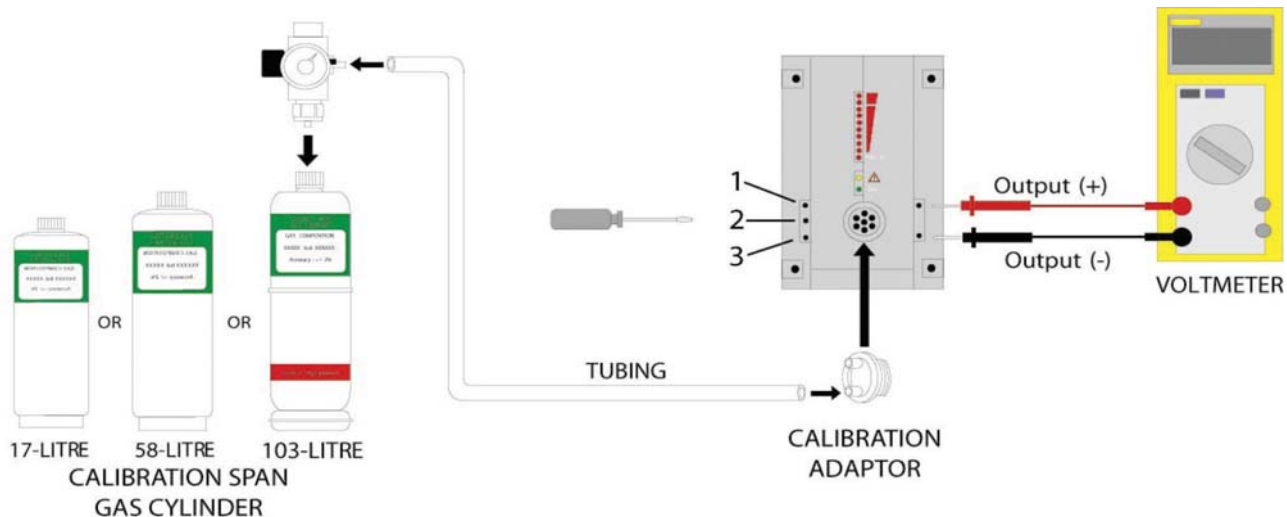

3. Adjusting the Zero (if required)

If you suspect the presence of the target gas, inject zero gas at the specified flow rate for a minimum of 1 minute prior to adjusting the potentiometer.

Adjust the zero potentiometer to read -35 mV.

This must be achieved in a well ventilated area where there is no presence of the target gas.

CAUTION :

For all Q2 except CO detectors bought after April 25, 2005, do the following steps:

Adjust the zero potentiometer to read 10 mV.

Very slowly, adjust the zero potentiometer to read 0 mV. Be careful do not go under 0 mV because the negative voltage won't be displayed.

4. Adjusting the Span

Turn on the regulator and inject span gas at the specified flow rate.

The span gas is now flowing into the unit.

After 2.5 minutes, the voltmeter readings should be stabilized.

Then adjust the span potentiometer to read the following value:

$$\frac{\text{Span Gas Value} \times \text{Factor} \times 2.5}{\text{Full scale}} = \text{Calibration value (in VDC) (+/- 3 \% \text{ of the scale})}$$

VA201T/M CALIBRATION INFORMATION - Q1 Sensor

Gas (Q1)	Sensor	VA201T Scale	VA201M Scale	Warm-Up	Factor	Zero Pot	Span Pot	Flow Rate L/min	Notes
CL2	SCL2-7CLH SCL2-S7	15.3 ppm	15 ppm	5 min.	-	-	2	0.5	
CO	SCO-4BW	0 - 255 ppm	0 - 250 ppm	5 min.	-	-	2	0.5	
Combustible	SCH4-VQ21TB	0 - 102%	0 - 100%	5 min.	Table 13	3	2	0.5	1% Volume CH4 = 20% LEL CH4
ETO	SETO-7ETO	0 - 20.4 ppm	0 - 20 ppm	5 min. *	-	3	2	1	* If no backup circuit for the sensor, 7 day warm up required
H2	SH2-3HYE	0 - 2.5 %	0 - 2.5 %	5 min.	-	-	2	0.5	
H2S	SH2S-7HH	0 - 51 ppm	0 - 50 ppm	5 min.	-	-	2	1	
HCL	SHCL-7HL	0 - 51 ppm	0 - 50 ppm	5 min. *	-	3	2	1	* If no backup circuit for the sensor, 7 day warm up required
HCN	SHCN-7HCN	0 - 51 ppm	0 - 50 ppm	5 min.	-	-	2	1	
NH3	SNH3-1000S	0 - 102 ppm	0 - 100 ppm	1 hour	-	3	2	0.5	
NO	SNO-7NT	0 - 102 ppm	0 - 100 ppm	5 min. *	-	3	2	1	* If no backup circuit for the sensor, 7 day warm up required
NO2	SNO2-B1	0 - 10.2 ppm	0 - 10 ppm	5 min.	-	3	2	1	
O2	SO2-4OX	0 - 25.5%	0 - 25%	5 min. **	-	-	2	0.5	** If no backup circuit for the sensor, 24 hour warm up required
SO2	SSO2-7SH	0 - 10.2 ppm	0 - 10 ppm	5 min.	-	-	2	1	
Smoke	SCO-7EF	0 - 35.7 ppm	0 - 35.7 ppm	5 min.	-	-	2	0.5	

VA201T/M CALIBRATION INFORMATION - Q2 Sensor

Gas (Q2)	Sensor	VA201T Scale	VA201M Scale	Warm-Up	Factor	Zero Pot	Span Pot	Flow Rate L/min	Notes
C3H8	SQ2-COMB	0 - 102%	0 - 100%	15 min.	-	2	1	0.04	
CH4	SQ2-COMB	0 - 102%	0 - 100%	15 min.	-	2	1	0.04	1% Volume CH4 = 20% LEL CH4
CO	SCO-MONOXC	0 - 255 ppm	0 - 250 ppm	5 min.	-	-	2	0.5	
SQ2-FIG	24 hours	2	1	0.04					
H2	SQ2-COMB	0 - 102%	0 - 100%	15 min.	-	2	1	0.04	1% Volume H2 = 25% LEL H2
Refrigerant	SQ2-FREON	0 - 1020 ppm	0 - 1000 ppm	24 hours	1.2	2	1	0.04	

500 ml/min = 30 l/h on regulator

CONVERSION FACTOR FOR COMBUSTIBLES (Q1)

Gas	Factor	Gas	Factor	Gas	Factor
1,2-Propylene Oxide	2.593	Ethyl Alcohol C ₂ H ₆ O	1.691	Methylhexane	2.376
1,3-Butadiene C ₄ H ₆	2.546	Ethyl Bromide	0.942	Methylpentane	2.705
1,4 Dioxane	2.513	Ethyl Chloride	1.748	M-Xylene	2.693
1,4-Hexadiene	1.504	Ethyl Formate	2.374	N-Butane	2.04
1-Butene C ₄ H ₈	2.146	Ethyl Mercaptan	1.75	N-butyl Alcohol C ₄ H ₁₀ O	3.042
1-Pentene	2.207	Ethyl Methyl Ether	2.305	N-Butyric Acid	2.433
1-Hexene	2.535	Ethylamine	1.394	N-Decane	3.413
Acetaldehyde	2.034	Ethyl Benzene	2.884	Neo-Pentane	2.388
Acetic Acid	3.413	Ethylene	1.537	N-Heptane	2.689
Acetic Anhydride	2.056	Ethylene Alcohol C ₂ H ₆ O ₂	1.7	N-Hexane	2.349
Acetone	2.208	Ethylene Dichloride	1.502	Nitromethane	2.146
Acetonitrile	2.328	Ethyl Pentane	2.354	N-Octane	2.854
Acetylene	1.665	Hydrazine	1.949	N-Pentane (gasoline)	2.21
Acrylonitrile	2.202	Hydrogen	1.233	N-Propyl Acetate	2.44
Aniline	2.985	I-Propyl Acetate	2.442	N-Propyl Alcohol	1.967
Benzene	2.512	Iso-Butane	1.832	N-Propyl Chloride	1.808
Carbonyl Sulphide	1.023	Iso-Butyl Alcohol	2.541	N-Propylamine	2.071
Chlorobenzene	2.976	Isobutylene	1.95	O-Xylene	2.998
Cis-Butene-2	2.051	Iso-Pentane	2.3	Propyne	2.304
Cis-Hexene (2&3)	2.525	Iso-Propyl Alcohol C ₃ H ₈ O	2.582	Propane C ₃ H ₈	1.883
Cyanogen	1.058	Methane	1	Propene C ₃ H ₆	1.837
Cyclohexane	2.492	Methyl Acetate	2.156	P-Xylene	2.772
Cyclopentane	1.966	Methyl Alcohol	1.46	sStyrene Monomer	2.665
Cyclopropane	1.518	Methyl Bromide	1.055	Tert-Butyl Alcohol	1.778
Deuterium	1.067	Methyl Chloride	1.297	Tetrahydrofuran	1.824
Diethyl Ether	2.285	Methyl Ethyl Ketone	2.631	Toluene C ₇ H ₈	2.47
Diiso-propyl Ether	2.342	Methyl Formate	1.857	Trans-Butene-2	1.882
Dimethyl Butane	2.683	Methylhydrazine	2.358	Trans-Hexene (2&3)	2.543
Dimethyl Ether	1.714	Methyl Mercaptan	1.602	Triethylamine	2.524
Dimethylhydrazine	1.424	Methyl Propionate	2.091	Trimethylamine	1.945
Dimethyl Sulphide	2.323	Methyl Propyl Ketone	2.694	Trimethylbutane	2.296
Dimethyl Pentane	2.317	Methylamine	1.25	Vinyl Acetate	1.904
Ethane	1.392	Methylcyclohexane	2.559	Vinyl Chloride	1.825
Ethyl Acetate	2.563	Methylene Chloride	1.026		



VA301D2 / GasPoint II

VA301D2/GasPoint II Calibration Procedure

IF YOUR TRANSMITTER WAS PURCHASED BEFORE APRIL 1, 2004, CONTACT TECHNICAL SUPPORT LINE AT 1-800-563-2967

1. Warm-Up Period

Turn the unit on for a minimum of fifteen (15) minutes.

Check Calibration Information for specific warm-up time.

GasPoint II CALIBRATION INFORMATION					
Gas	Scale	Warm-up	Factor	Flow Rate	Notes
Combustible	0 -102% LEL	15 min.	Table II	500 ml/min	1% Volume CH4 = 20% LEL CH4.
Infrared Combustible	0 – 102% LEL	15 min.	Table III	500 ml/min	2.5% Volume CH4 = 50% LEL CH4.
CL2	0 - 15.3 ppm	15 min.	N/A	500 ml/min	
CO	0 - 255 ppm	N/A	N/A	500 ml/min	
ETO	0 - 20.4 ppm	15 min.	N/A	500 ml/min	
H2S	0 - 51.0 ppm	15 min.	N/A	500 ml/min	
HCL	0 - 25.5 ppm	15 min.	N/A	500 ml/min	
HCN	0 - 51.0 ppm	15 min.	N/A	500 ml/min	
HF	0 - 10.2 ppm	15 min.	0.2	500 ml/min	Nitrogen dioxide surrogate for HF
NO	0 - 102 ppm	15 min.	N/A	500 ml/min	
NO2	0 - 10.2 ppm	15 min.	N/A	500 ml/min	
O2	0 -25.5%	N/A	N/A	500 ml/min	
SO2	0 -10.2 ppm	15 min.	N/A	500 ml/min	
SIH4	0 -10.2 ppm	15 min.	N/A	500 ml/min	
F2	0 – 2.6 ppm	15 min	1.3	500 ml/min	CL2 surrogate gas for F2

500 ml/min = 30 l/h on regulator

2. Connecting the Hardware

Plug the calibration adaptor onto the gas sensor inlet.

Screw the regulator to the calibration Span gas cylinder for the Span adjustment or Zero gas cylinder for the Zero adjustment and set the appropriate flow rate.

Connect the regulator outlet to the calibration adaptor.

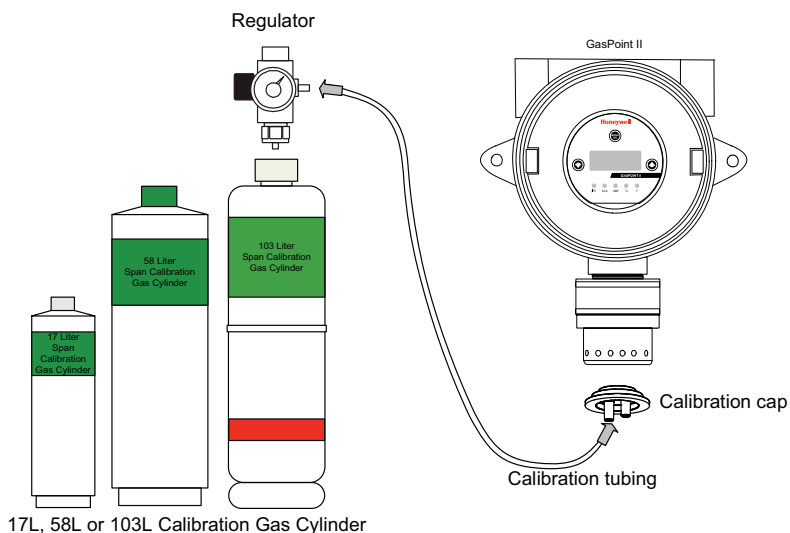

3. Adjusting the Zero (if required)

When the unit indicates 0 %/ppm in an area with no presence of the target gas, proceed to step 4.

Turn on the regulator.

The calibration zero gas is now flowing into the unit.

Wait for 2.5 minutes minimum to allow the reading to stabilize.

Place the magnet on top of Menu.

Then place it above Up or Down arrow until the password VA is reached.

Place the magnet on top of Menu to acknowledge.

Place the magnet on top of Up or Down arrow until the Set Zero field is reached.

Place the magnet on top of Menu to acknowledge.

Place the magnet on top of Menu to activate GoCalib.

Wait message appears, the transmitter will go into zero calibration.

The calibration procedure is finished when the Menu Set Zero message appears.

Place the magnet on top of Up or Down arrow until the Quit field is reached.

Place the magnet on top of Menu to confirm.

4. Adjusting the Span

Turn on the regulator.

The calibration span gas is now flowing into the unit.

Wait for 2.5 minutes minimum to allow the reading to stabilize.

Place the magnet on top of Menu.

Then place it above Up or Down arrow until the password VA is reached.

Place the magnet on top of Menu to acknowledge.

Place the magnet on top of Up or Down arrow until the Set Span field is reached.

Place the magnet on top of Menu to acknowledge.

Place the magnet on top of Up or Down arrow to select the proper gas value multiplied by the conversion factor, if needed.

Once the span gas value is selected, place the magnet on top of Menu to acknowledge.

When GoCalib? Is displayed, place the magnet on top of Menu to start the calibration.

Wait message appears, the transmitter will go into auto calibration mode.

During the calibration, Set Span and gas reading are displayed

The calibration procedure is finished when the Menu Set Span message appears.

Place the magnet on top of Up or Down arrow until the Quit field is reached.

Place the magnet on top of Menu to exit.

GasPoint II CONVERSION FACTOR FOR COMBUSTIBLES (PELLISTOR)

Gas	Factor	Gas	Factor	Gas	Factor
1,2-Propylene Oxide	2.593	Ethyl Alcohol C ₂ H ₆ O	1.691	Methylhexane	2.376
1,3-Butadiene C ₄ H ₆	2.546	Ethyl Bromide	0.942	Methylpentane	2.705
1,4 Dioxane	2.513	Ethyl Chloride	1.748	M-Xylene	2.693
1,4-Hexadiene	1.504	Ethyl Formate	2.374	N-Butane	2.04
1-Butene C ₄ H ₈	2.146	Ethyl Mercaptan	1.75	N-butyl Alcohol C ₄ H ₁₀ O	3.042
1-Pentene	2.207	Ethyl Methyl Ether	2.305	N-Butyric Acid	2.433
1-Hexene	2.535	Ethylamine	1.394	N-Decane	3.413
Acetaldehyde	2.034	Ethyl Benzene	2.884	Neo-Pentane	2.388
Acetic Acid	3.413	Ethylene	1.537	N-Heptane	2.689
Acetic Anhydride	2.056	Ethylene Alcohol C ₂ H ₆ O ₂	1.7	N-Hexane	2.349
Acetone	2.208	Ethylene Dichloride	1.502	Nitromethane	2.146
Acetonitrile	2.328	Ethyl Pentane	2.354	N-Octane	2.854
Acetylene	1.665	Hydrazine	1.949	N-Pentane	2.21
Acrylonitrile	2.202	Hydrogen	1.233	N-Propyl Acetate	2.44
Aniline	2.985	I-Propyl Acetate	2.442	N-Propyl Alcohol	1.967
Benzene	2.512	Iso-Butane	1.832	N-Propyl Chloride	1.808
Carbonyl Sulphide	1.023	Iso-Butyl Alcohol	2.541	N-Propylamine	2.071
Chlorobenzene	2.976	Isobutylene	1.95	O-Xylene	2.998
Cis-Butene-2	2.051	Iso-Pentane	2.3	Propyne	2.304
Cis-Hexene (2&3)	2.525	Iso-Propyl Alcohol C ₃ H ₈ O	2.582	Propane C ₃ H ₈	1.883
Cyanogen	1.058	Methane	1	Propene C ₃ H ₆	1.837
Cyclohexane	2.492	Methyl Acetate	2.156	P-Xylene	2.772
Cyclopentane	1.966	Methyl Alcohol	1.46	sStyrene Monomer	2.665
Cyclopropane	1.518	Methyl Bromide	1.055	Tert-Butyl Alcohol	1.778
Deuterium	1.067	Methyl Chloride	1.297	Tetrahydrofuran	1.824
Diethyl Ether	2.285	Methyl Ethyl Ketone	2.631	Toluene C ₇ H ₈	2.47
Diiso-propyl Ether	2.342	Methyl Formate	1.857	Trans-Butene-2	1.882
Dimethyl Butane	2.683	Methylhydrazine	2.358	Trans-Hexene (2&3)	2.543
Dimethyl Ether	1.714	Methyl Mercaptan	1.602	Triethylamine	2.524
Dimethylhydrazine	1.424	Methyl Propionate	2.091	Trimethylamine	1.945
Dimethyl Sulphide	2.323	Methyl Propyl Ketone	2.694	Trimethylbutane	2.296
Dimethyl Pentane	2.317	Methylamine	1.25	Vinyl Acetate	1.904
Ethane	1.392	Methylcyclohexane	2.559	Vinyl Chloride	1.825
Ethyl Acetate	2.563	Methylene Chloride	1.026		

Gas Point II CONVERSION FACTOR FOR COMBUSTIBLES (INFRARED)

Gas	Factor	Gas	Factor	Gas	Factor	Gas	Factor
Acetone	0.025	Ethylacetate	0.600	Hydrogen	--	Octane	0.600
Acetylene	0.050	Ethylene	0.010	Isopropyl Alcohol	0.800	Pentane	1.000
Butane	0.900	Heptane	0.800	Methane	0.350	Propane	1.000
Cyclohexane	0.800	Hexane	0.750	Methylethyl Ketone	0.400	Toluene	0.150
						Unleaded petrol	0.550



301IRFS / S301D2 with VA301EM

301IRFS / S301D2 with VA301EM Calibration Procedure

1. Warm-Up Period

Turn the unit on for a minimum of fifteen (15) minutes.

Check Calibration Information for specific warm-up time.

2. Connecting the Hardware

Plug the calibration adaptor onto the gas sensor inlet.

Screw the regulator to the calibration Span gas cylinder for the Span adjustment or Zero gas cylinder for the Zero adjustment and set the appropriate flow rate.

VA301EM CALIBRATION INFORMATION

Gas	Scale	Warm-up	Factor	Flow Rate	Notes
Combustible	0 - 102% LEL	15 min	Table II	500 ml/min	1% Volume CH ₄ = 20% LEL CH ₄ .
CL ₂	0 - 15.3 ppm	15 min	N/A	500 ml/min	
CO	0 - 255 ppm	N/A	N/A	500 ml/min	
ETO	0 - 20.4 ppm	15 min	N/A	500 ml/min	
H ₂ S	0 - 51.0 ppm	15 min	N/A	500 ml/min	
HCL	0 - 25.5 ppm	15 min	N/A	500 ml/min	
H ₂ CN	0 - 51.0 ppm	15 min	N/A	500 ml/min	
HF	0 - 10.2 ppm	15 min	0.2	500 ml/min	Nitrogen dioxide is a surrogate gas for HF
NO	0 - 102 ppm	15 min	N/A	500 ml/min	
NO ₂	0 - 10.2 ppm	15 min	N/A	500 ml/min	
O ₂	0 - 25.5%	N/A	N/A	500 ml/min	
SO ₂	0 -10.2 ppm	15 min	N/A	500 ml/min	
SIH ₄	0 -10.2 ppm	15 min	N/A	500 ml/min	
F ₂	0 – 2.6 ppm	15 min	1.3	500 ml/min	CL ₂ is a surrogate gas for F ₂
Refrigerant Rxxx	0 – 1000 ppm	15 min	N/A	100 ml/min	Replace the xxx by the required refrigerant

Connect the regulator outlet to the calibration adaptor.

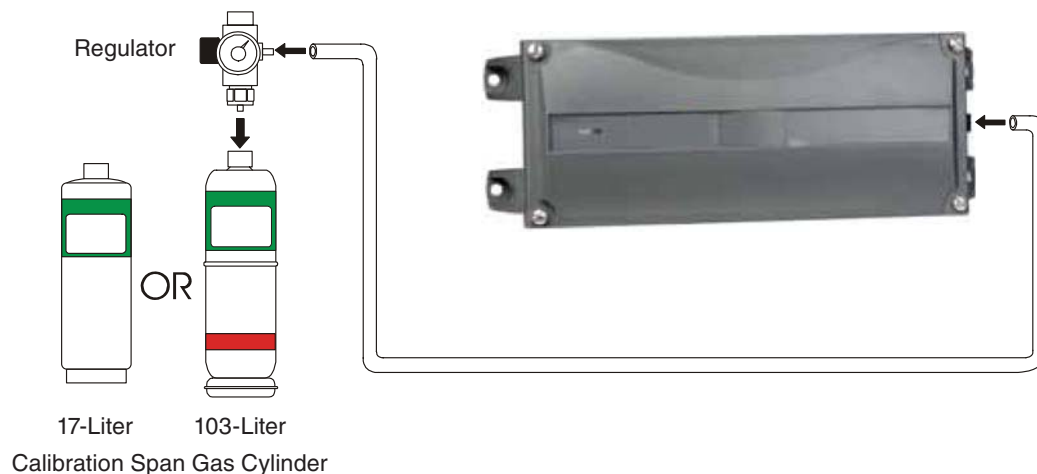

301IRFS Calibration Installation

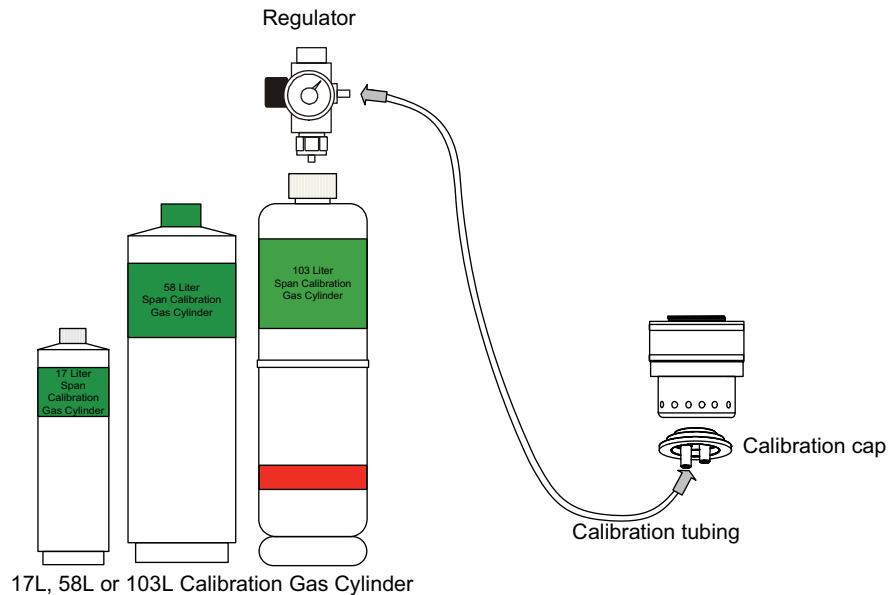

S301D2 Calibration Installation

3. Adjusting the Zero (if required)

When the unit indicates 0 %/ppm in an area with no presence of the target gas, proceed to step 4.

To adjust the zero, inject zero gas at the specified flow rate.

The zero calibration gas is now flowing into the unit.

Let the gas flow for a minimum of 2.5 minutes.

After 2.5 minutes, the reading should be stabilized.

Press Enter to get into the menu.

Use the Up or Down button until the password VA is reached.

Press Enter to acknowledge.

Use the Up or Down arrow until the Set Zero field is reached.

Press Enter to acknowledge.

Use the Up or Down arrow to select the sensor to be calibrated.

Press Enter to acknowledge.

Press Enter again to activate GoCalib.

Wait message appears, the transmitter will go into zero calibration.

The calibration procedure is finished when the Menu Set Zero message appears.

Use the Up or Down arrow until the Quit field is reached.

Press Enter to exit.

4. Adjusting the Span

Turn on the regulator.

The calibration span gas is now flowing into the unit.

Let the gas flow for a minimum of 2.5 minutes.

After 2.5 minutes, the reading should be stabilized.

Press Enter to get into the menu.

Use the Up or Down button until the password VA is reached.

Press Enter to acknowledge.

Use the Up or Down arrow until the Set Span field is reached.

Press Enter to acknowledge.

Use the Up or Down arrow to select the sensor to be calibrated.

Press Enter to acknowledge.

Use the Up or Down button to set the span gas value multiplied by the conversion factor, if needed (See table below).

Press Enter to acknowledge.

Press Enter again to activate GoCalib.

Wait message appears, the transmitter will go into span calibration.

The calibration procedure is finished when the Menu Set Span message appears.

Use the Up or Down arrow until the Quit field is reached.

Press Enter to exit.

VA301EM CONVERSION FACTOR FOR COMBUSTIBLES (PELLISTOR)

Gas	Factor	Gas	Factor	Gas	Factor
1,2-Propylene Oxide	2.593	Ethyl Alcohol C ₂ H ₆ O	1.691	Methylhexane	2.376
1,3-Butadiene C ₄ H ₆	2.546	Ethyl Bromide	0.942	Methylpentane	2.705
1,4 Dioxane	2.513	Ethyl Chloride	1.748	M-Xylene	2.693
1,4-Hexadiene	1.504	Ethyl Formate	2.374	N-Butane	2.04
1-Butene C ₄ H ₈	2.146	Ethyl Mercaptan	1.75	N-butyl Alcohol C ₄ H ₁₀ O	3.042
1-Pentene	2.207	Ethyl Methyl Ether	2.305	N-Butyric Acid	2.433
1-Hexene	2.535	Ethylamine	1.394	N-Decane	3.413
Acetaldehyde	2.034	Ethyl Benzene	2.884	Neo-Pentane	2.388
Acetic Acid	3.413	Ethylene	1.537	N-Heptane	2.689
Acetic Anhydride	2.056	Ethylene Alcohol C ₂ H ₆ O ₂	1.7	N-Hexane	2.349
Acetone	2.208	Ethylene Dichloride	1.502	Nitromethane	2.146
Acetonitrile	2.328	Ethyl Pentane	2.354	N-Octane	2.854
Acetylene	1.665	Hydrazine	1.949	N-Pentane	2.21
Acrylonitrile	2.202	Hydrogen	1.233	N-Propyl Acetate	2.44
Aniline	2.985	I-Propyl Acetate	2.442	N-Propyl Alcohol	1.967
Benzene	2.512	Iso-Butane	1.832	N-Propyl Chloride	1.808
Carbonyl Sulphide	1.023	Iso-Butyl Alcohol	2.541	N-Propylamine	2.071
Chlorobenzene	2.976	Isobutylene	1.95	O-Xylene	2.998
Cis-Butene-2	2.051	Iso-Pentane	2.3	Propyne	2.304
Cis-Hexene (2&3)	2.525	Iso-Propyl Alcohol C ₃ H ₈ O	2.582	Propane C ₃ H ₈	1.883
Cyanogen	1.058	Methane	1	Propene C ₃ H ₆	1.837
Cyclohexane	2.492	Methyl Acetate	2.156	P-Xylene	2.772
Cyclopentane	1.966	Methyl Alcohol	1.46	sStyrene Monomer	2.665
Cyclopropane	1.518	Methyl Bromide	1.055	Tert-Butyl Alcohol	1.778
Deutarium	1.067	Methyl Chloride	1.297	Tetrahydrofuran	1.824
Diethyl Ether	2.285	Methyl Ethyl Ketone	2.631	Toluene C ₇ H ₈	2.47
Diiso-propyl Ether	2.342	Methyl Formate	1.857	Trans-Butene-2	1.882
Dimethyl Butane	2.683	Methylhydrazine	2.358	Trans-Hexene (2&3)	2.543
Dimethyl Ether	1.714	Methyl Mercaptan	1.602	Triethylamine	2.524
Dimethylhydrazine	1.424	Methyl Propionate	2.091	Trimethylamine	1.945
Dimethyl Sulphide	2.323	Methyl Propyl Ketone	2.694	Trimethylbutane	2.296
Dimethyl Pentane	2.317	Methylamine	1.25	Vinyl Acetate	1.904
Ethane	1.392	Methylcyclohexane	2.559	Vinyl Chloride	1.825
Ethyl Acetate	2.563	Methylene Chloride	1.026		



VA301M / S301M

VA301M Calibration Procedure

1. Warm-Up Period

If the VA301M doesn't have a display, remove the cover and plug in a cover with display in J3.

Turn the unit on for a minimum of five (5) minutes.

Check Calibration Information for specific warm-up time.

VA301M CALIBRATION INFORMATION			
Gas	Scale	Warm-up	Flow Rate
CO	0 - 250 ppm	5 min	500 ml/min
NO2	0 - 10 ppm	5 min	500 ml/min
C3H8	0 - 50% LEL	15 min	50 ml/min
CH4	0 - 100% LEL	5 min	500 ml/min
H2	0 - 100% LEL	5 min	500 ml/min

2. Connecting the Hardware

Screw the regulator to the appropriate calibration gas cylinder.

Adjust the regulator with the suitable flow rate.

Plug the calibration adaptor onto the gas sensor inlet.

Connect the regulator outlet to the calibration adaptor as shown.

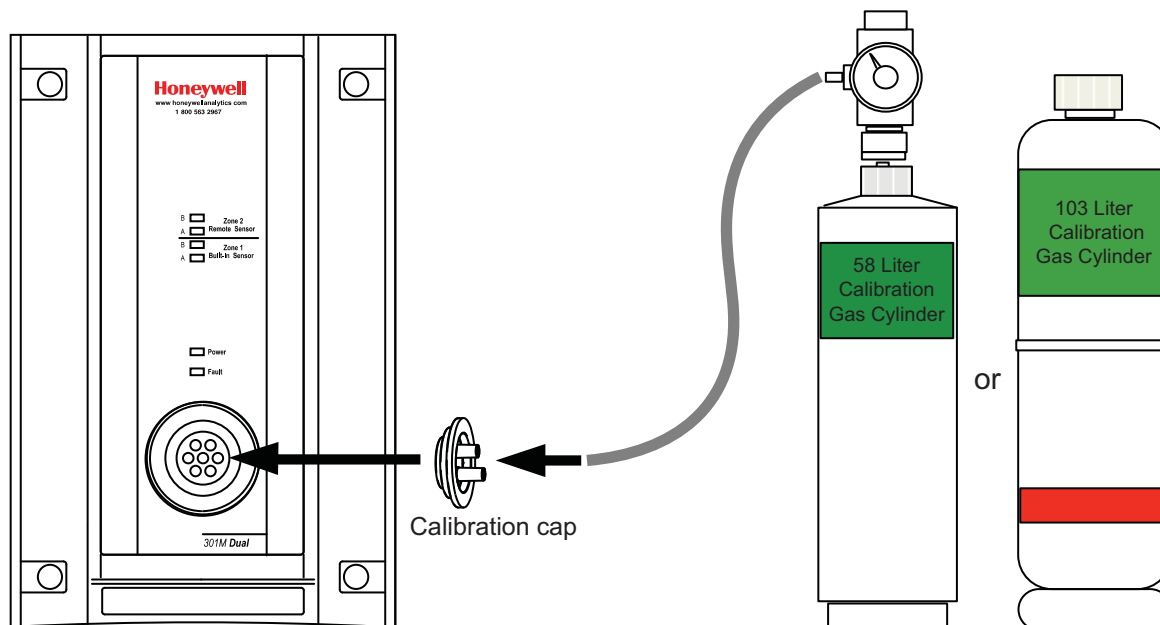

3. Adjusting the Zero (if required)

This must be achieved in a well ventilated area where there is no presence of the target gas.

If you suspect the presence of the target gas in the area, inject zero gas at the specified flow rate for a minimum of 2 minutes prior to doing a Set Zero.

Press the Enter key, and using the Scroll key enter the VA password.

Using the Scroll key select Zone 1 (built-in CO sensor) or Zone 2 (remote sensor) and press Enter.

Scroll to get the Set Zero menu.

Press Enter to start the zero calibration.

Wait will be displayed on the screen until calibration is completed.

Scroll until Back is displayed, press Enter.

Scroll until Quit is displayed, press Enter to exit.

4. Adjusting the Span

Turn on the regulator and inject span gas at the specified flow rate.

The span gas is now flowing into the unit.

Wait 2 minutes before starting the Set Span calibration.

Press the Enter key, and using the Scroll key enter the VA password.

Using the Scroll key select Zone 1 (built-in CO sensor) or Zone 2 (remote sensor) and press Enter.

Scroll to get the Set Span menu and press Enter to go in.

Using the Scroll and Enter key, input the concentration of span gas that's going to be used.

Wait will be displayed on the screen until calibration is completed.

Scroll until Back is displayed, press Enter.

Scroll until Quit is displayed, press Enter to exit.

S301M Calibration Procedure

1. Warm-Up Period

Turn the unit on for a minimum of fifteen (15) minutes.

2. Connecting the Hardware

Screw the regulator to the appropriate calibration gas cylinder.

Adjust the regulator with a flow rate of according to specification.

S301M CALIBRATION INFORMATION			
Gas	Scale	Warm-up	Flow Rate
CO	0 - 255 ppm	15 min	0.5L/min
NO2	0 - 10.2 ppm	15 min	0.5L/min
C3H8	0 - 25.5 % Vol	15 min	100 ml/min
Combustibles	0 - 102 %	15 min	100 ml/min

Connect the regulator outlet to the sensor as shown on.

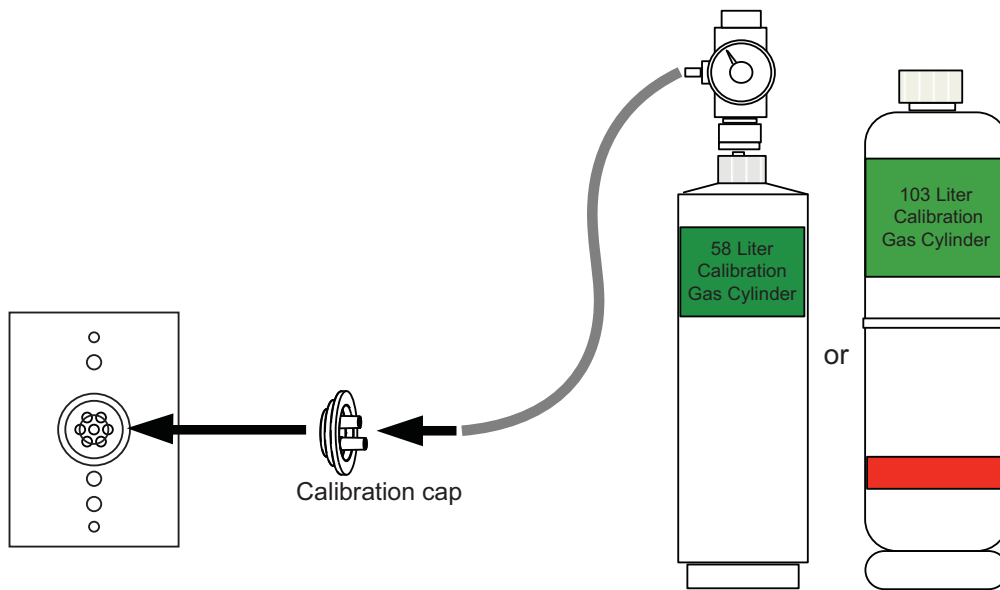

S301M Calibration Equipment

3. Remote Calibrating the S301M Sensor

When using the S301M in a network of sensors, connected to a VA301C controller (with firmware 3.0 or

higher), it is possible to perform a “remote calibration” using the VA301C menu:

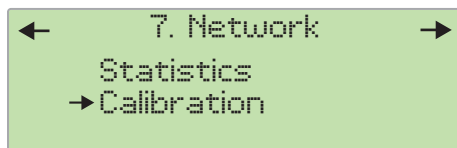

1. Using the navigation arrows, access the VA301C’s menu
2. Scroll through the menu options and select option 7. Network
3. Scroll through the Network options screens to the last screen and select the Calibration option

The Calibration screen contains four (4) lines of information:

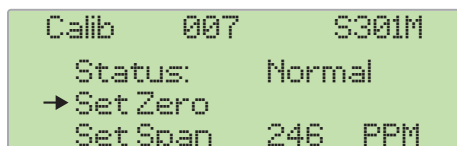

Line 1: Indicates the mode (Calib, meaning calibration), the (Modbus) address of the device to calibrate (007) and the type of device to calibrate (S301M)

Line 2: Indicates the status (Normal or In calib) of the specified device

Line 3: Displays the function to perform (Set Zero)

Line 4: Displays the function to perform (Set Span) and the span gas concentration value (246 ppm)

1. On the first line, scroll to the device address and press Enter
2. Scroll through the devices to display the desired device* and press Enter to select.
3. The second line displays the device status
4. Scroll to select the desired function, Set Zero to set the device’s zero, and press Enter to select.

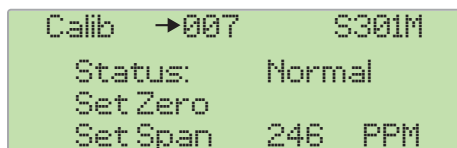

5. Upon pressing Set Zero, the controller requests confirmation.
6. Press Enter to confirm or Esc to cancel. If confirmed, the controller sets the S301M’s Zero. This takes only a few moments and the display returns to the default calibration screen.
7. To calibrate the device, scroll to Set Span** and change the span gas calibration value using this procedure;

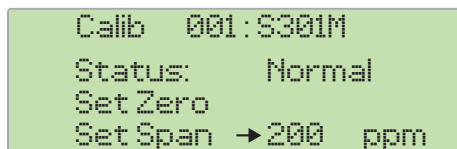

- a. Using the right arrow, move the cursor to xxx PPM (span value field). Press Enter to select the field (it’s editable when flashing).
- b. Use the up or down arrows to increase or decrease the value, press Enter to validate the new value.
- c. Move the cursor back to Set Span and press Enter to start the calibration.

The device Span is being calibrated. The screen will display the device status as “In calib...” until the calibration is complete.

*The device must be configured in the VA301C’s database in order to be included in the device addresses displayed on screen.

**When selecting Set Span, make sure that the device has been exposed to the appropriate calibration gas.



VA301W Wireless Transmitter

301W Calibration Procedure

1. Warm-Up Period

Turn the unit on for a minimum of fifteen (15) minutes.

2. Connecting the Hardware

Screw the regulator to the appropriate calibration gas cylinder.

Adjust the regulator with a flow rate of according to specification

301W CALIBRATION INFORMATION				
Gas	Scale	Warm-up	Flow Rate	Notes
CO	0 - 255 ppm	15 min	0.5L/min	
NO ₂	0 – 10.2 ppm	15 min	1L/min	
O ₂	0 – 25.5 % Vol.	15 min	0.5L/min	

Connect the regulator outlet to the sensor as shown.

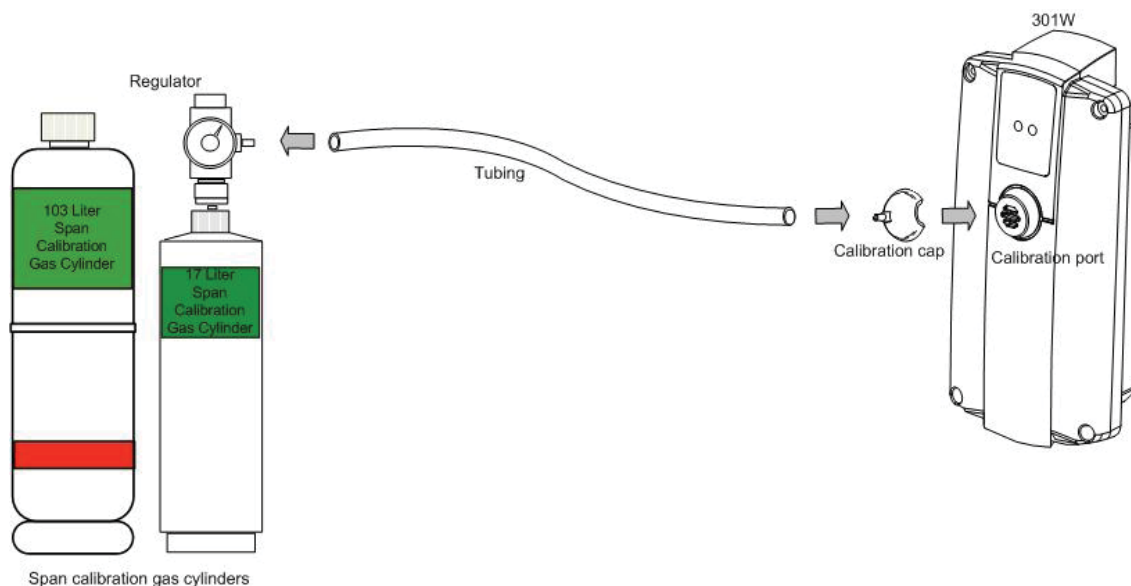

3. Remote Calibrating the 301W Sensor

When using the 301W in a network of sensors, connected to a 301C controller (with firmware 3.0 or higher), it is possible to perform a “remote calibration” using the 301C menu:

1. Using the navigation arrows, access the 301C’s menu
2. Scroll through the menu options and select option 7. Network
3. Scroll through the Network options screens to the last screen and select the Calibration option

```

Calib  121  301W
Status:  In calib...
Set Zero
Set Span → 246 PPM
    
```

The Calibration screen contains four (4) lines of information:

Line 1: Indicates the mode (Calib, meaning calibration), the (Modbus) address of the device to calibrate (121) and the type of device to calibrate (301W)

Line 2: Indicates the status (Normal or In calib...) of the specified device

Line 3: Displays the function to perform (Set Zero)

Line 4: Displays the function to perform (Set Span) and the span gas concentration value (246 ppm)

4. On the first line, scroll to the device address and press Enter

```
Calib  → 121      301W
Calibrate Zero?
Set Zero
Set Span  246 PPM
```

5. Scroll through the devices to display the desired device* and press Enter to select.
6. The second line displays the device's status
7. Scroll to select the desired function, Set Zero to set the device's zero, and press Enter to select.

```
Calib  121      301W
Status: Normal
→ Set Zero
Set Span  246 PPM
```

8. Upon pressing Set Zero, the controller requests confirmation.
9. Press Enter to confirm or Esc to cancel. If confirmed, the controller sets the S301M's Zero. This takes only a few moments and the display returns to the default calibration screen.
10. To calibrate the device, scroll to Set Span** and change the span gas calibration value using this procedure;
11. Using the right arrow, move the cursor to xxx PPM (span value field). Press Enter to select the field (it is editable when flashing).
12. Use the up or down arrows to increase or decrease the value, press Enter to validate the new value.
13. Move the cursor back to Set Span and press Enter to start the calibration.

The device Span is being calibrated. The screen will display the device's status as "In calib..." until the calibration is complete.

*The device must be configured in the 301C's database in order to be included in the device addresses displayed on screen.

**When selecting Set Span, make sure that the device has been supplied with the appropriate calibration gas before and during the calibration process.



705 / Sensepoint Combustible

705 Sensor and Sensepoint Combustible

Refer to controller or transmitter for calibration instructions.



90DM4

90DM4 Calibration Procedure

Make sure that the unit has completed its warm up cycle (approximately 15 minutes) before beginning the calibration.

Connecting the Hardware

1. Plug the calibration adaptor onto the gas sensor inlet.
2. Screw the regulator to the calibration zero gas cylinder and adjust the flow rate to 0.5L/min.
3. Connect the regulator outlet to the calibration adaptor as shown

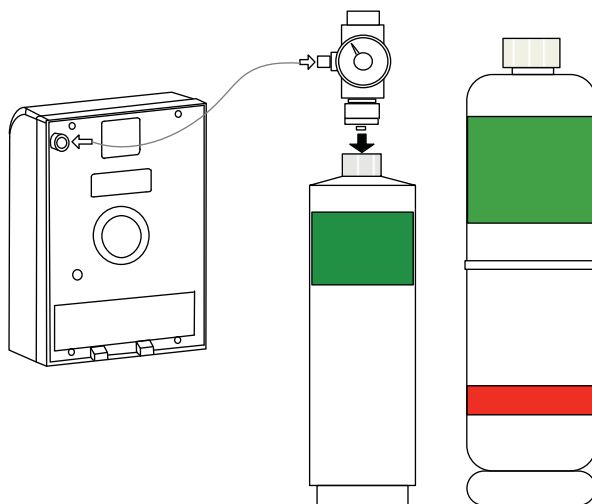

17L or 103L Calibration Gas Cylinders

Adjusting the Zero (units without display)

1. Turn on the regulator.
2. The nitrogen Zero gas is now flowing into the unit.
3. Let the gas flow for a minimum of 10 minutes.
4. Press the left button once and wait for the red LED to begin flashing.
5. Press the left button again to confirm the start of calibration.
6. The red LED will then blink quickly during the entire calibration process.
7. The calibration procedure is finished when the red LED blinks normally.

Adjusting the Zero (units with display)

Access to the 90DM4 programming is achieved through push buttons located on the back of the device, accessible through an oblong cut-out. The left hand button opens access to programming functions and validates selections (equivalent to an Enter button). The right hand button scrolls through main programming screens and increases values when in a specific programming screen.

- Hold the unit (facing you) in both hands
 - Place both index fingers through the cut-out until they touch the left and right push buttons, respectively.
 - Press the left button to access the programming menus.
1. Turn on the regulator. The nitrogen is now flowing into the unit. Wait for 10 minutes minimum to allow the reading to stabilize.
 2. Press the left pushbutton to access the menu.
 3. Use the right pushbutton to change the letters one at a time; when the password VA is displayed press the left pushbutton to confirm.

4. Use the right pushbutton button to scroll to the Set Zero option and press the left pushbutton to confirm.
5. When GoCalib is displayed, press the right pushbutton button to display Yes.
6. Press the left pushbutton to start the Zero calibration.
7. A *Wait* message is displayed while the unit is being calibrated.
8. The calibration is complete when the display shows the Cal. Zero Complete message. The display returns to the Menu Set Zero screen.
9. Use the right pushbutton button to scroll to the Quit field and press the left pushbutton to exit.

Calibrating the Span (units with display)

Access to the 90DM4 programming is achieved through push buttons located on the back of the device, accessible through an oblong cut-out. The left hand button opens access to programming functions and validates selections (equivalent to an Enter button). The right hand button scrolls through main programming screens and increases values when in a specific programming screen.

- Hold the unit (facing you) in both hands
 - Place both index fingers through the cut-out until they touch the left and right push buttons, respectively.
 - Press the left button to access the programming menus.
1. Turn on the regulator. The calibration gas is now flowing into the unit. Wait for 10 minutes minimum to allow the reading to stabilize.
 2. Press the left pushbutton to access the menu.
 3. Use the right pushbutton to change each letter until the password VA is reached.
 4. Press the left pushbutton to confirm each letter.
 5. Use the right pushbutton to scroll to the Menu Set Span screen.
 6. Press the left pushbutton to select.
 7. In the GoCalib screen, press the right button to scroll to Yes and press the left pushbutton to start the calibration.
 8. Wait message appears, the transmitter will go into Span calibration.
 9. The calibration procedure is finished when the Menu Set Span message appears.
 10. Press the right pushbutton until the Quit screen is displayed and press the left pushbutton to exit.

90DM4 Calibration Information			
Gas	Scale	Warm-up	Notes
N2	0 - 2000 ppm	15 min	



Apex Transmitter and Sensor

Apex Calibration Procedure

The following equipment is required:

- Flow Housing accessory (Part No: 2110B2140) - fitted with rubber seal and supplied with loose hydrophobic filter
- Test gas
- Regulator

NOTE

Zero gas and Span gas should be at roughly the same humidity levels to avoid erroneous cell responses.

A hydrophobic filter is supplied loose with the Flow Housing which must be fitted when calibrating sensors with flammable gas cartridges.

When calibrating sensors fitted with other cartridge types then the filter mounted in the sensor cap for normal gas sensing operation (if one was used) should be fitted to the Flow Housing.

1. At the Certified Sensor remove the cap or accessory.

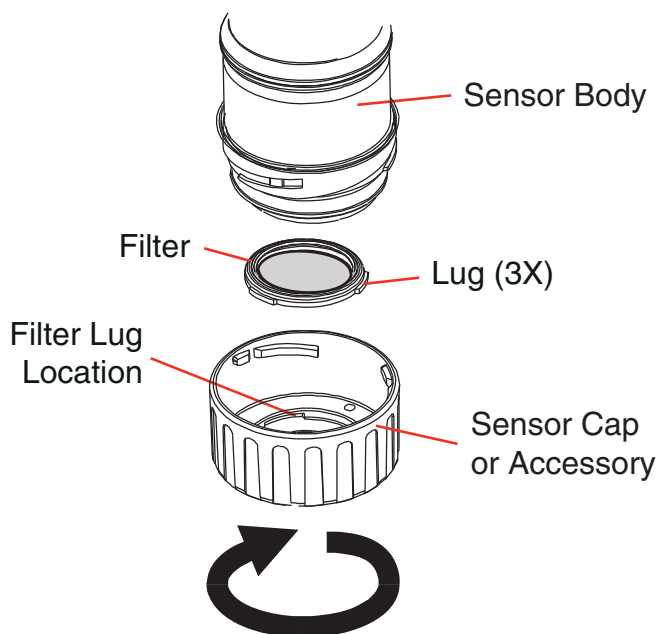

2. If calibrating a sensor with a non-flammable gas cartridge remove the filter, if fitted, from the sensor cap/ accessory and fit it to the Flow Housing.

If fitted, the filter is held in place in the cap/accessory by its three lugs. Carefully pry the filter free from the lug location points in the cap or accessory.

If calibrating a sensor with a flammable gas cartridge fit the hydrophobic filter supplied with the Flow Housing into the housing.

In either case, to fit a filter into the Flow Housing, first remove the factory-fitted seal from the Flow Housing. The seal is held in place in the housing by its three lugs. Carefully pry the seal free from the lug location points in the housing.

The filter then locates in the Flow Housing in the same way as the removed seal. Ensure that the filter is placed in the Flow Housing the correct way round with the three lugs closest to the front face of the housing (where the gas pipes exit) and correctly engaged in the location points.

3. Fit the Flow Housing onto the Certified Sensor body.

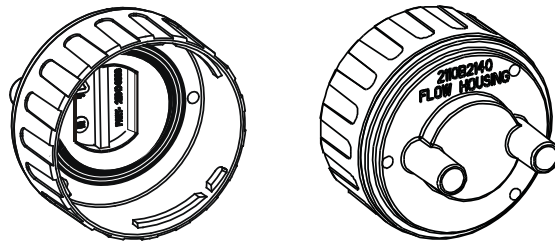

The following diagram shows the Flow Housing accessory fitted to the Certified Sensor.

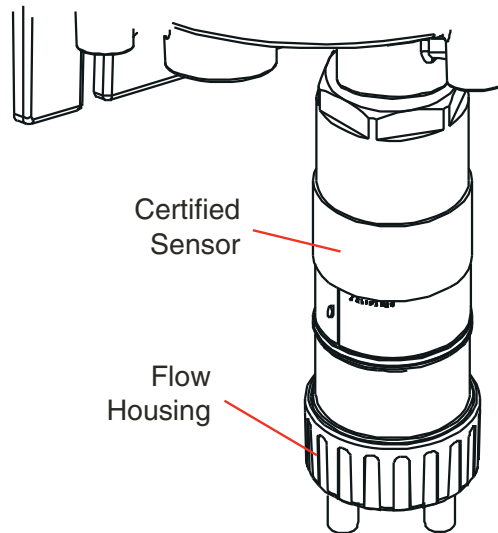

4. Press the esc button at the Transmitter Unit and the Main Menu is displayed.



5. Navigate to the Calibration Menu option using the up/down keys.

6. Press ok.

7. Enter the current Level 2 password. The Calibration Menu is displayed.



8. Navigate to the Gas Calibrate option using the up/down keys.

9. Press ok, Zero Calibration screen is displayed with the message: Zero Gas then <OK>

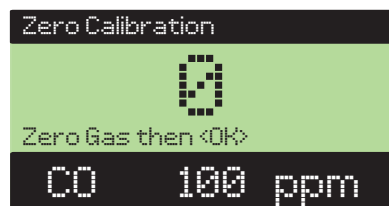

10. Ensure there is no gas present on the Certified Sensor.

If gas is suspected to be in the vicinity of the sensor either check the area using a calibrated portable gas sensing device, e.g. Honeywell Analytic's Impact, or flow clean air over the Certified Sensor using the Flow Housing accessory.

11. Press ok. The Transmitter Unit zeros the sensor. The LCD screen displays the message: Calibrating - Wait. When successfully completed the LCD screen shows the message: Success! OK:Continue

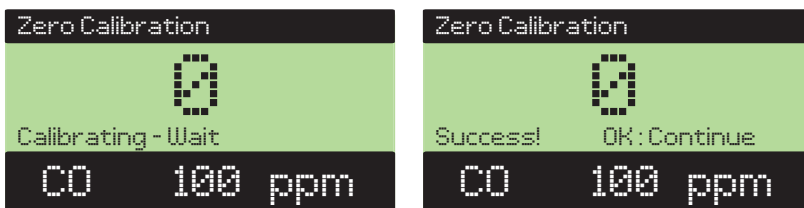

12. Press ok. The Span Calibration screen is displayed with the message: Calibrate? OK/ESC. This gives the choice to stop the calibration procedure at this point (after zero calibration) or continue to include the span and full gas calibration.

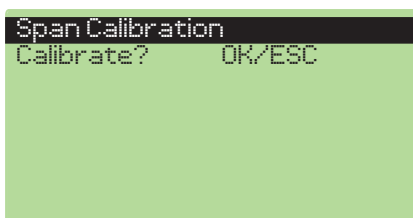

13. Press ok to continue with Span Calibration. To skip the span calibration process, press the esc key.

⚠ WARNING

If Span Calibration is not required you MUST exit the process at this point otherwise the sensor will be damaged.

NOTE

At this point, depending on the type of gas cartridge fitted to the sensor, a choice of two calibration gases may be displayed, e.g. C_7H_8 has the options C_7H_8 and CH_4 as choices. If so choose the one that will be used for calibration and press ok. Otherwise the process continues at the following step.

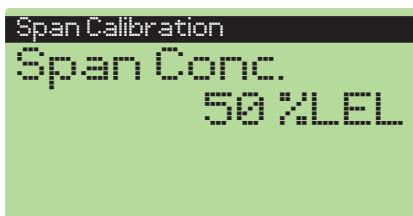

14. Set the required test gas Span Conc. value using the up/down keys.

15. Press ok. The LCD screen displays the message: Apply Gas then <OK>

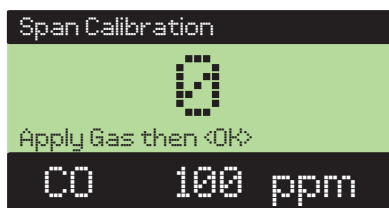

16. Connect the Flow Housing (using either gas pipe) to the regulated cylinder containing a known concentration of the target gas at approximately the sensor alarm point, e.g. 50% LEL Methane in air.

It is recommended for most sticky gases the tubing should be PTFE with short pieces of rubber tube to

make the final connection due to the inflexibility of PTFE. This minimizes adhesion of the gas to the tube surface and allows for more accurate measurement.

WARNING

As some test gases may be hazardous, the Flow Housing outlet should exhaust to a safe area.

17. Apply the target gas to the Certified Sensor at a rate of between 0.7l/m and 1.0l/m. Wait for the gas reading to stabilize before continuing.

NOTE

Certified Sensors should be calibrated at concentrations representative of those to be measured. It is always recommended that the Certified Sensor is calibrated with the target gas it is to detect.

CAUTION

Where the user calibrates any Certified Sensor using a different gas, responsibility for identifying and recording calibration rests with the user. Refer to the local regulations where appropriate.

18. Press ok, the LCD screen displays the message: Calibrating - Wait



19. When calibration is successfully completed the message is displayed: Success! OK:Continue



Ensure that the sensor and the vicinity around it is clear all traces of the calibration gas before continuing. This is to avoid triggering spurious alarms.

If calibration fails at any point discard the cartridge and replace with a new one.

20. Press ok, the Calibration Menu is displayed again.



21. Press the esc button twice. The Main Menu and then the Gas Reading screen is displayed.
22. Remove the test equipment, refit the sensor cap to the sensor (with reinstalled filter if previously removed for the test) and return the system to normal operation.



E³Point

E³Point Calibration Procedure

Set Zero Menu



Only use the Set Zero function when the unit no longer displays zero. This option allows users to set the sensor Zero. In the main Set Zero screen, press enter to begin. If there is a remote sensor connected, you must scroll to select Z1 (built-in sensor) or Z2 (remote sensor).



- Before starting the calibration, connect the regulator to the appropriate cylinder (nitrogen for all sensors except combustible, which uses air).
- Adjust the flow rate to the indicated rate.
- Connect the tubing from the regulator to the sensor calibration cap as shown below.
- Let the gas flow for at least 3 minutes before starting calibration.
- The next screen requests confirmation. Use the arrow keys to display Yes and press enter to confirm.

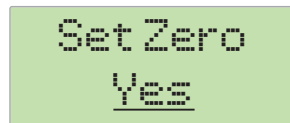

A confirmation screen briefly displays and the zero calibration begins.

A success or failure message displays and the screen returns to the main menu option.

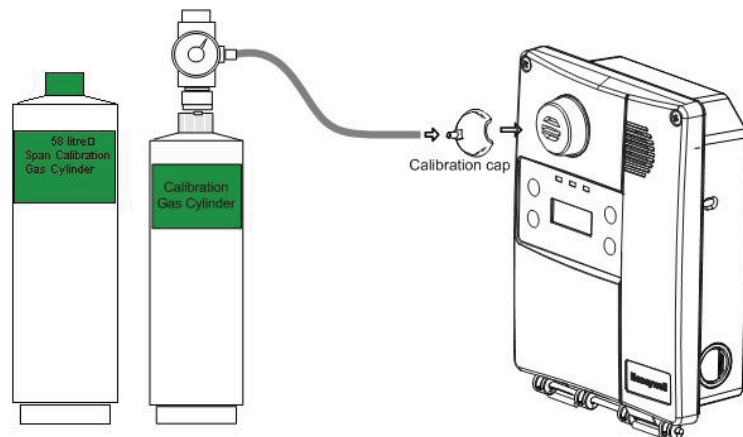

Calibration Installation

Set Span Menu



WARNING: If the calibration gas concentration exceeds alarm setpoints, alarms will be triggered. Either change alarm levels so the alarms are not triggered, or put the entire system in service mode so no external equipment (lights, fans, ventilators, buzzers) will be activated.



Only use the Set Span function when inspection or calibration maintenance indicate that it is necessary. See Periodic Inspection and Maintenance.

This option allows users to calibrate the sensor's span. In the main Set Span screen, press enter to begin. If there is a remote sensor connected, you must scroll to select Z1 (built-in sensor) or Z2 (remote sensor). Before starting calibration, connect the regulator to the gas cylinder.

```
*Menu*
Set Zero
```

```
Set Zero
Z1
```

- Adjust the flow rate to 0.5 L/min.
- Connect the tubing from the regulator to the sensor calibration cap. See Figure 1.



If the gas is not allowed to flow for at least 3 minutes, it will affect the calibration accuracy.

The next screen allows you to specify the span calibration gas concentration value.

```
Set Gas
200 ppm
```

```
Set Span
Yes
```

- Use the arrow keys to increase or decrease the value and press enter to select.
- The next screen requests confirmation.
- Let the gas flow for at least 3 minutes before starting the calibration.
- Press enter to confirm and the screen displays the concentration during calibration.

```
Set Span
198 ppm
```

A success or failure message displays and the screen returns to the main menu option.



Manning EC-F2

EC-F2 Calibration Procedure

General Information

The Manning EC-F2 sensor should be calibrated a minimum of once every six months, or after exposure to a large concentration of gas. The Manning EC-F2 sensor generally becomes less sensitive with age, therefore regular calibration is critical to maintain the accuracy of the sensor.

Zero Calibration

After the unit is installed and has been powered up for a minimum of 24 hours, the unit should be zero calibrated by the following two procedures.

NOTE: If the sensor output is erratic immediately after the installation of a new cell, it may be a high gain (span) setting left over from a previous cell that was adjusted for aging.

- Be sure the unit is in clean air, or apply zero air at 1.0 L/min.
- Adjust the zero pot until the sensor outputs 4.0 mA (40 mV from Test [—] to Test [+]).

Span Calibration

- Perform zero adjustment before spanning.
- The table below shows what span gas to use and what the signal should be for various sensor ranges:

Sensor Range (ppm)	Span Gas (ppm)	Calibrated Signal Voltage (mV)
0—100	100	200
0—250	100	104
0—250	250	200
0—500	250	120
0—1,000	1,000	200

- Place calibration adapter firmly over the sensor.
- Apply span gas at 1.0 L/min (span gas must be in air, not nitrogen or other carrier).
- After span gas has been on sensor for two minutes, adjust the span pot until the correct output is achieved.

For combinations not shown in the previous table, use the following formula to determine the output:

$$\text{Signal (mA)} = \left[\frac{\text{SGC}}{\text{SFSV}} \times 16 \right] + 4$$

Where:

SGC = Span Gas Concentration,

SFSV = Sensor Full Scale Value.

For example if 100 ppm SGC gas is used to calibrate a 250 ppm SFSV sensor, the signal would be as follows:

$$\text{Signal} = \left[\frac{100\text{ppm}}{250\text{ppm}} \times 16 \right] + 4 = 10.4 \text{ mA}$$

$$10.4 \text{ mA} = 104 \text{ mV from TEST (—) to TEST (+)}$$

If the correct output cannot be achieved, a replacement cell is required.

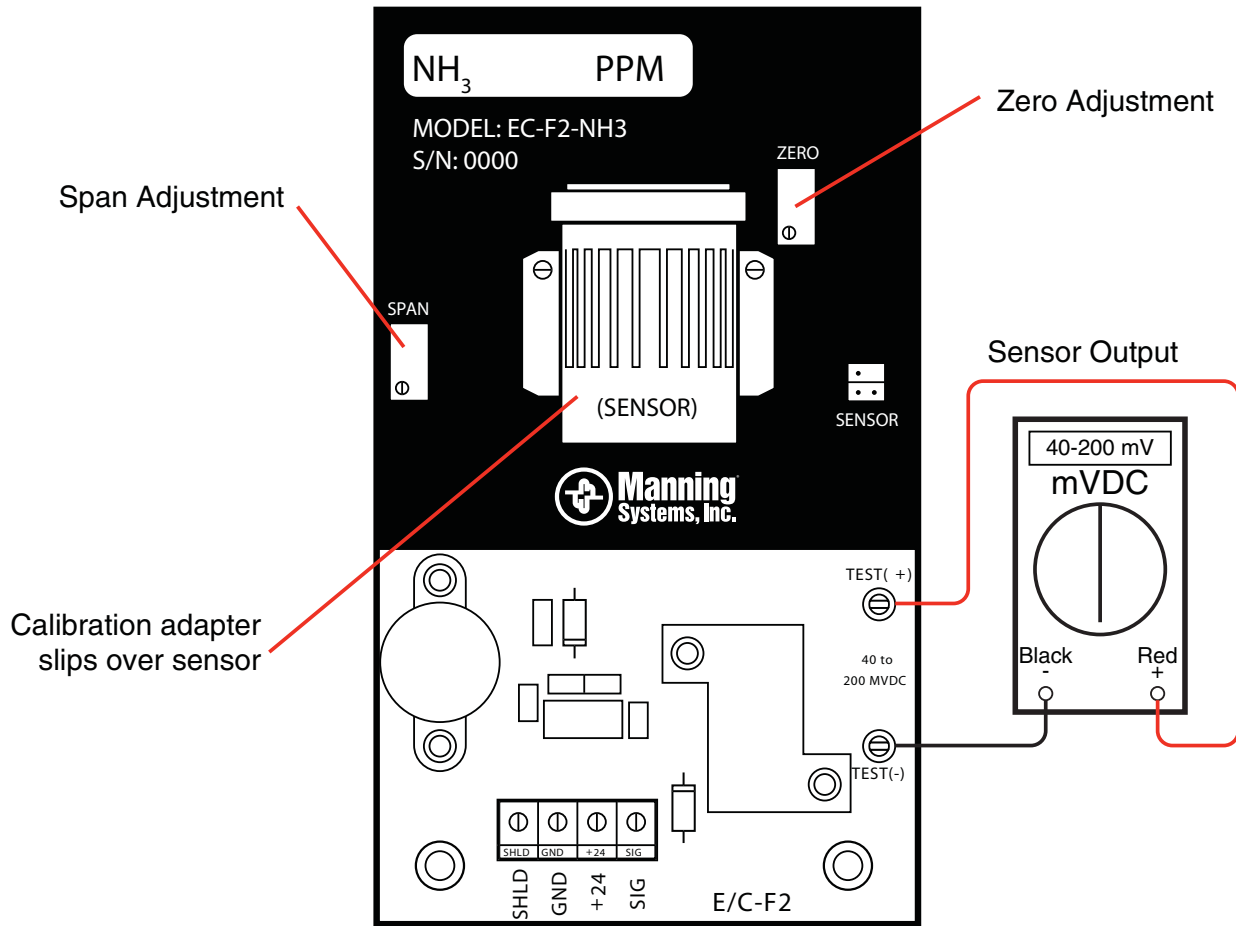

Zero and span adjustments on the Manning EC-F2 Sensor



Manning EC-F3-02

EC-F3-O2 Calibration Procedure

General Information

The Manning EC-F3 oxygen sensor comes factory calibrated but may require a span adjustment upon installation to compensate for local altitude and barometric pressure conditions.

Effects of Barometric Pressure on Oxygen

The output of the Manning EC-F3-O2 sensor is affected by changes in barometric pressure. If a unit is calibrated at a barometric pressure of 29.00 inches Hg in clean air to output 20.9 % O₂, and the barometric pressure changes to 28.00 inches Hg, the output will indicate 20.2 % O₂. Because of this, the installer should always perform a nominal calibration as described below when the unit is started up. After the nominal calibration is performed, the output will be expected to vary slightly with barometric pressure.

Nominal Calibration: After the unit is installed and has been powered up for a minimum of 8 hours, a nominal calibration will be achieved by the following method.

- Be sure the unit is in clean air with the area well ventilated.
- The sensor should indicate a concentration of approximately 20.9 %, which is the normal concentration of oxygen in clean air. This will vary depending on elevation and barometric pressure.
- Adjust the span pot until the sensor output indicates a concentration of 20.9 %. For the following ranges, the test signals should be:

Range 0-25%

0.0% = 4 mA or 40 mV (TP1-TP2)

25% = 20 mA or 200 mV (TP1-TP2)

Range 15-25%

15% = 4 mA or 40 mV (TP1-TP2)

25% = 20 mA or 200 mV (TP1-TP2)

Zero Calibration

DO NOT adjust the zero pot without certified calibration gas. If zero adjustment is required, the following procedure will zero the unit.

- Apply zero gas at 1.0 L/min (zero gas must be in nitrogen).
- After zero gas has been on sensor for two minutes, adjust the zero pot until the correct output is achieved.

Span Calibration

Span calibration can be achieved by performing the nominal calibration described at the beginning of this section or by using calibration gas as follows:

- Perform zero adjustment before spanning.
- Apply span gas at 1.0 L/min (span gas must be in nitrogen).
- After span gas has been on sensor for two minutes, adjust the span pot until the correct output is achieved.

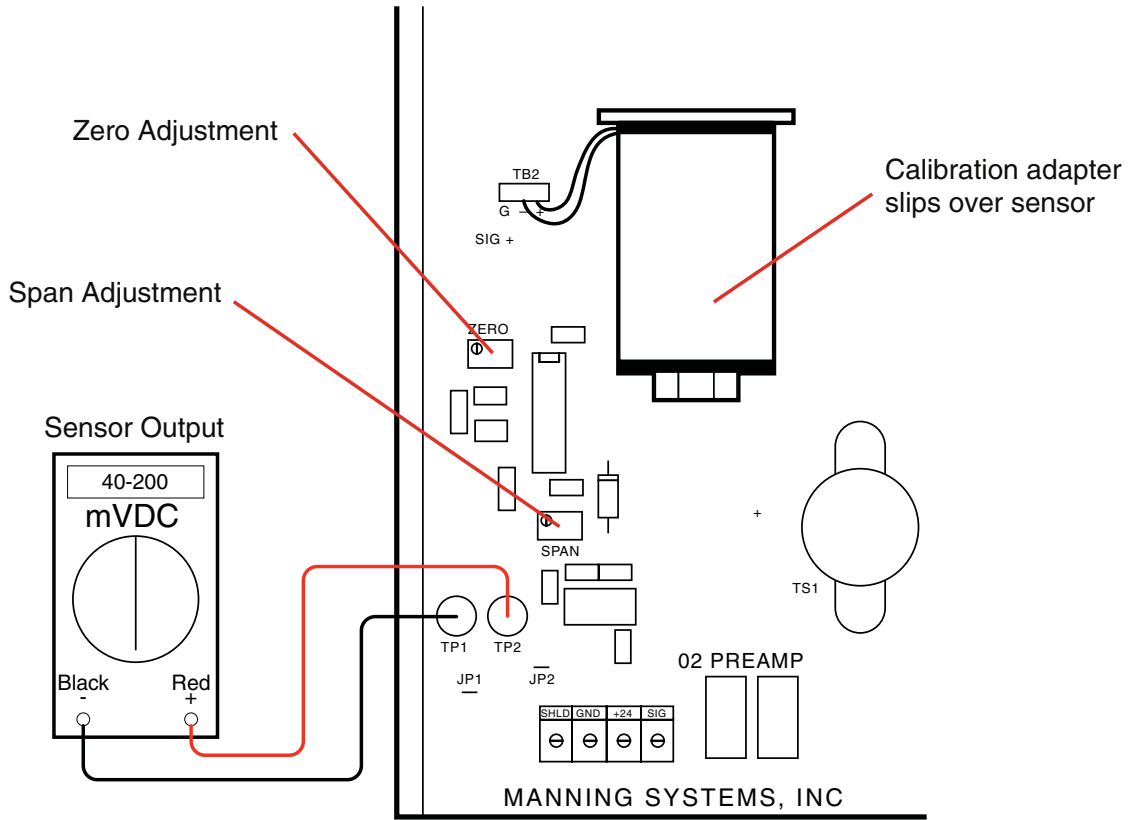

Zero and span adjustments to the Manning EC-F3-O2 Sensor



Manning EC-F9-NH3

EC-F9-NH3 Calibration Procedure

General Information

The Manning EC-F9 sensor should be calibrated a minimum of once every six months, or after exposure to a large concentration of gas. The Manning EC-F9 generally becomes less sensitive with age, therefore regular calibration is critical to maintain the accuracy of the sensor.

Refer to the Manning EC-F9 sensor manual for more in-depth calibration procedure details.

Zero Calibration

There is no zero pot as the pre-amp is factory zeroed and should not require any further adjustment.

Span Calibration

NOTE: If the sensor output is erratic immediately after the installation of a new cell, it may be a high gain (span) setting left over from a previous cell that was adjusted for aging.

- Confirm that the sensor is in clean air or there is no ammonia present. Output should not be more than 4.6 mA (46 mV from Test[—] to Test[+]).
- The table below shows what span gas to use and what the signal should be for various sensor ranges:

Sensor Range (ppm)	Span Gas (ppm)	Calibrated Signal Voltage (mV)
0—100	100	200
0—250	250	200
0—250	100	104
0—500	250	120
0—1,000	1,000	200

- Place calibration adapter firmly over the sensor.
- Apply span gas at 1.0 L/min (span gas must be in air, not nitrogen or other carrier).
- After span gas has been on sensor for two minutes, adjust the span pot until the correct output is achieved.
- For combinations not shown in the previous table, use the following formula to determine the output:

$$\text{Signal (mA)} = \left[\frac{\text{SGC}}{\text{SFSV}} \times 16 \right] + 4$$

Where:

SGC = Span Gas Concentration,

SFSV = Sensor Full Scale Value.

For example, if 100 ppm SGC gas is used to calibrate a 250 ppm SFSV sensor, the signal would be as follows:

$$\text{Signal} = \left[\frac{100 \text{ ppm}}{250 \text{ ppm}} \times 16 \right] + 4 = 10.4 \text{ mA}$$

$$10.4 \text{ mA} = 104 \text{ mV from TEST (—) to TEST (+)}$$

If the correct output cannot be achieved, a replacement cell is required.

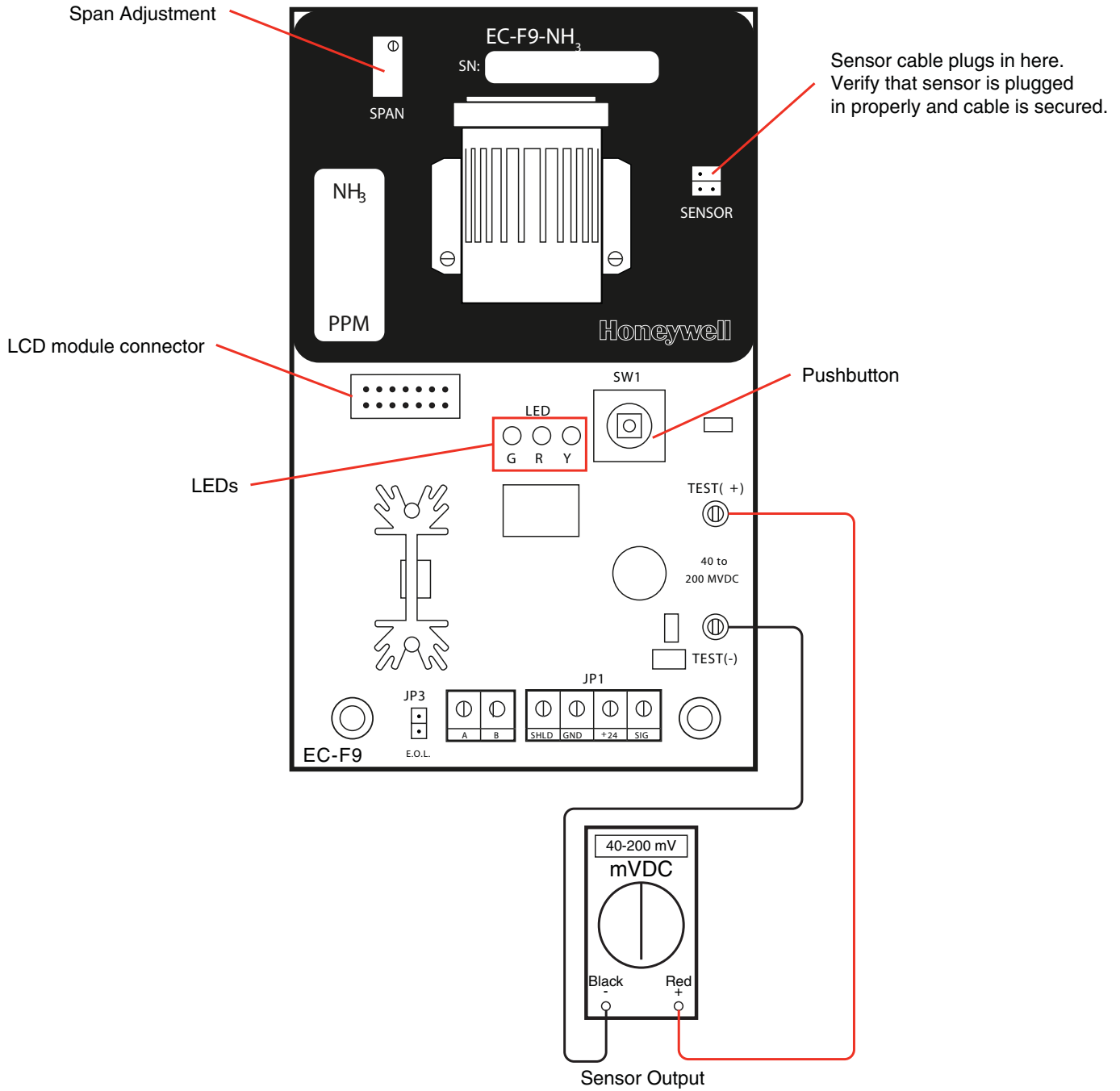

Zero and Span Adjustments on the EC-F9



Honeywell

Calibration Guide

Manning EC-P2

EC-P2 Calibration Procedure

General Information

Calibration is recommended every six months in normal use. Each SMART-CELL stores its calibration and alarm setpoint information on its own internal memory chip. When the SMART-CELL is plugged into the Manning EC-P2, this information is used by the EC-P2. The SMART-CELL can be field calibrated by the user or returned to Honeywell Analytics for factory calibration.

The calibration procedure requires the use of a bypass tee to allow the gas to be drawn into the flow cell without creating variable pressure or dilution problems. Calibration gas cannot be fed into the flow cell under pressure.

When applying calibration gas, use the bypass tee as shown in the illustration below. The flowrate of calibration gas should be high enough that at least 0.5 SCFH is flowing out of the calibration tee. This can be measured with the supplied flowmeter and insures that air is not being drawn into the unit and diluting the calibration gas.

The unit may be zeroed without spanning it; however, never span the unit without first zeroing it.

Entering Zero/Span Mode

- Push power button to turn unit on. Wait for power up sequence to finish (30 seconds).
- Push and hold the unnamed button (second from left) first, then push and hold the MENU button. Hold both buttons until the screen goes blank (2 seconds). Release both buttons and the unit is now in Programming Mode.
- Push the SENS button and the unit is now in the zero/span mode.

Zero Calibration

- Be sure the unit is in clean air or apply zero air for two minutes.
- Push ZERO button.
- Push SAVE button to save the new zero calibration.

Span Calibration

- Push SPAN button.
- Apply span gas for two minutes.
- Push INC button (increase) or DEC button (decrease) until the display matches the span gas concentration.
- Push SAVE button to store new span calibration.

Exiting Zero/Span Mode

- Push DONE button twice slowly to get back into normal operation mode.

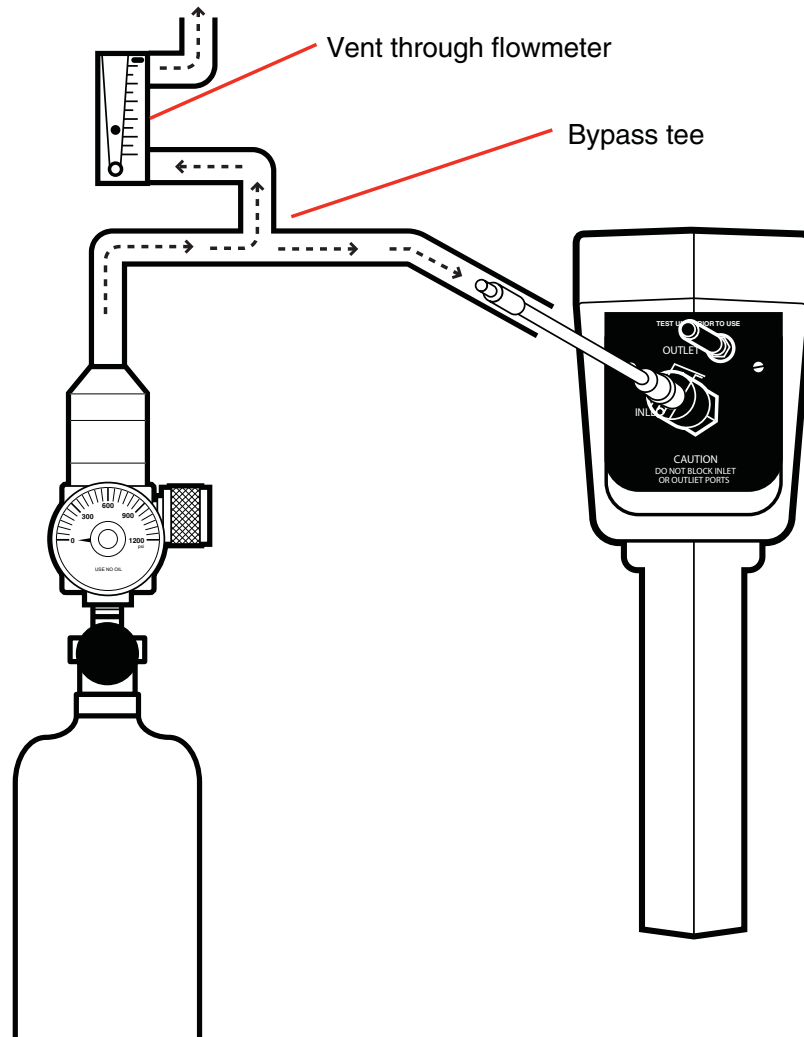

Calibration of the Manning EC-P2 Sensor using a bypass tee



Searchline Excel

Unit Alignment and Zero Cal with XNX

Use same procedure for aligning transmitter and receiver

1. Loosen clamp nuts and adjustment clamp screws on transmitter and receiver until they move freely in all axes

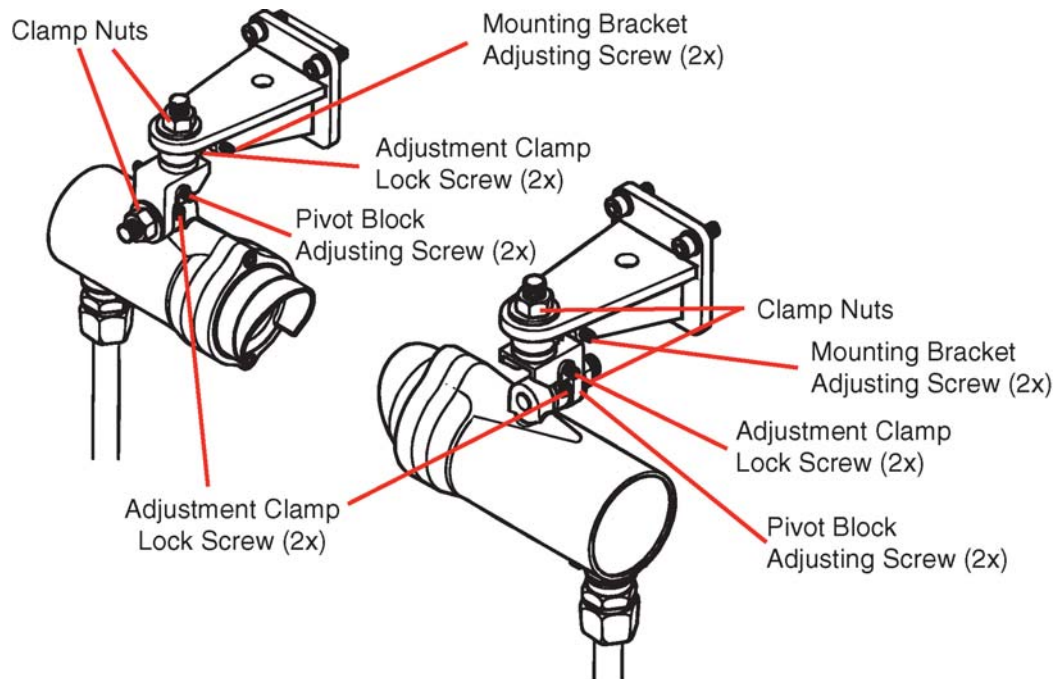

2. Point transmitter and receiver so they face each other
3. Tighten clamp nuts and adjustment clamp screws on each unit until they cannot be moved by hand

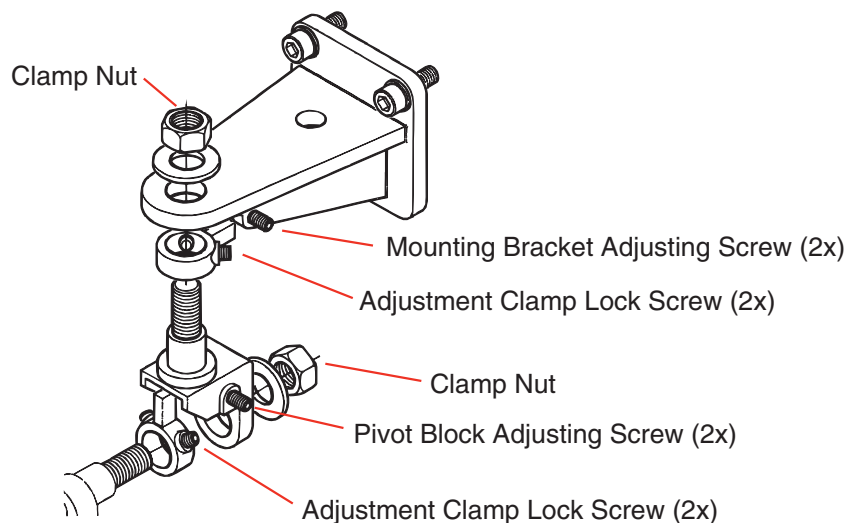

4. Clamp nuts and screws should not need further tightening
5. Additional tightening will affect fine adjustment and should be avoided
6. Unit can still be moved by adjustment screws
7. Before adjustment check front face of units to determine telescope type. Trident-type Excel units have three small pads, non-Trident types do not.

Pads provide contact points for alignment telescope assembly datum insures accurate telescope attachment so alignment is precise.

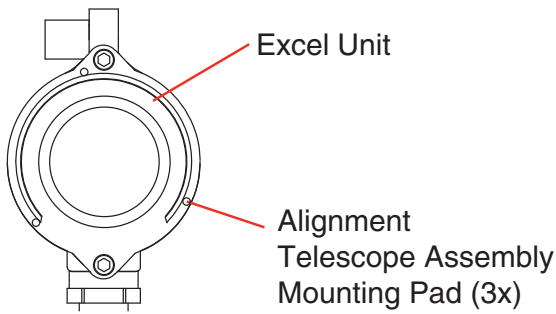

Trident-type

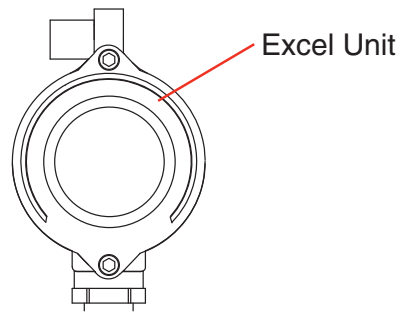

Non-trident-type

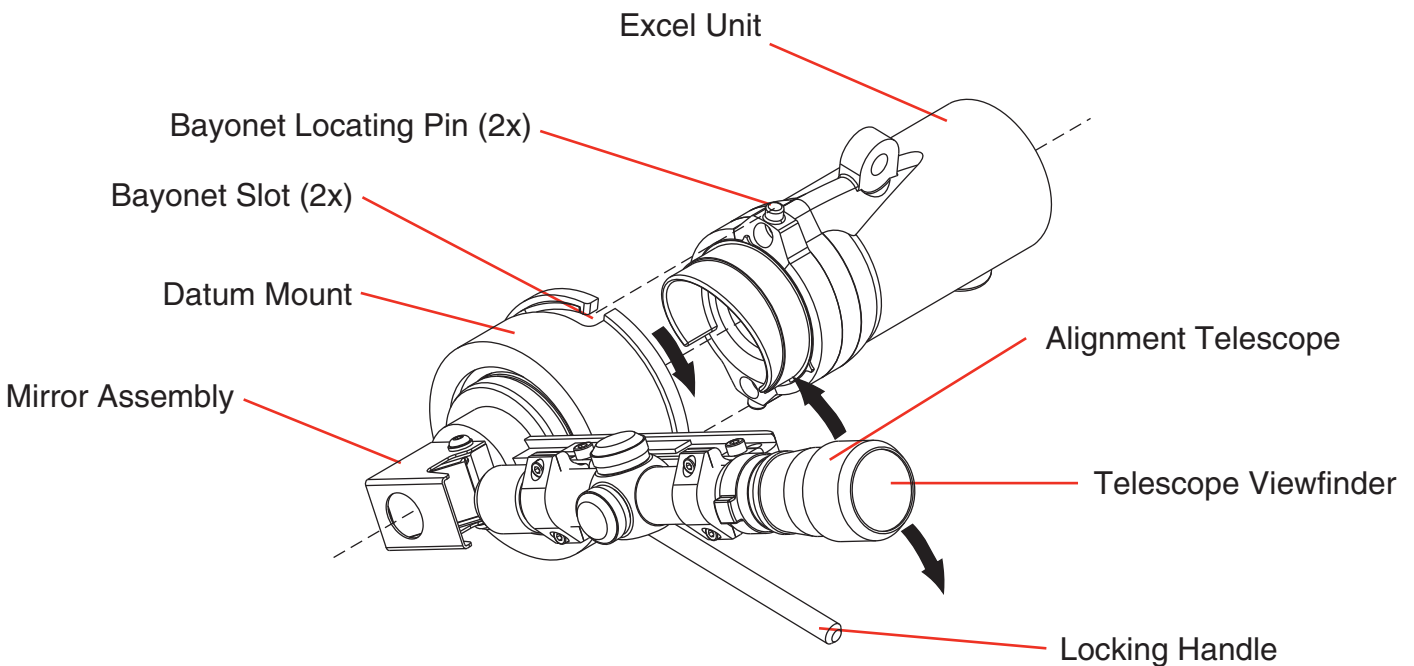
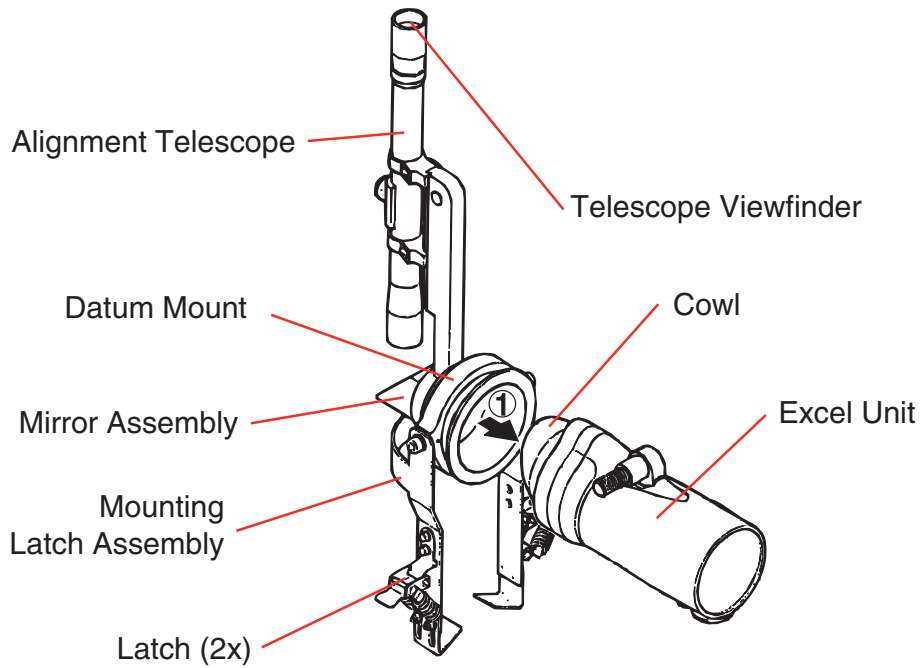

8. Latch-style assembly consists of

- Telescope and mirror
- Latching mechanism
- Can be used with Trident or non-Trident units

Fit datum mount of alignment telescope securely over unit cowl so mirror face is visible. Ensure datum mount is fully seated on cowl. Undo latches on telescope's mounting latch assembly and rotate assembly so parallel support bar fits underneath unit as indicated by arrow 2. Locate latch mounting hooks behind back of unit. Rotate telescope to a comfortable viewing position, then secure latches as indicated by arrow 3.

Proceed with alignment

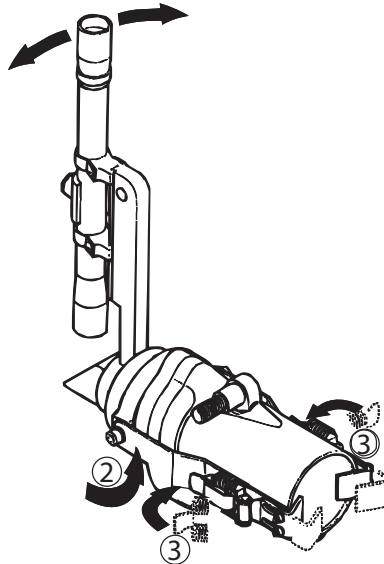

9. Bayonet-style Assembly only used with Trident-type Excel units - assembly consists of

- Telescope and mirror
- Datum mount
- Bayonet attachment
- Datum mount handle for rotating and locking assembly

Align telescope's two bayonet slots with two locating pins on unit cowl and seat telescope mount fully on cowl. Rotate telescope to a comfortable viewing position and hold it in that position. Use mount's locking handle to rotate bayonet fitting in a clockwise direction until securely locked on cowl.

Proceed with alignment

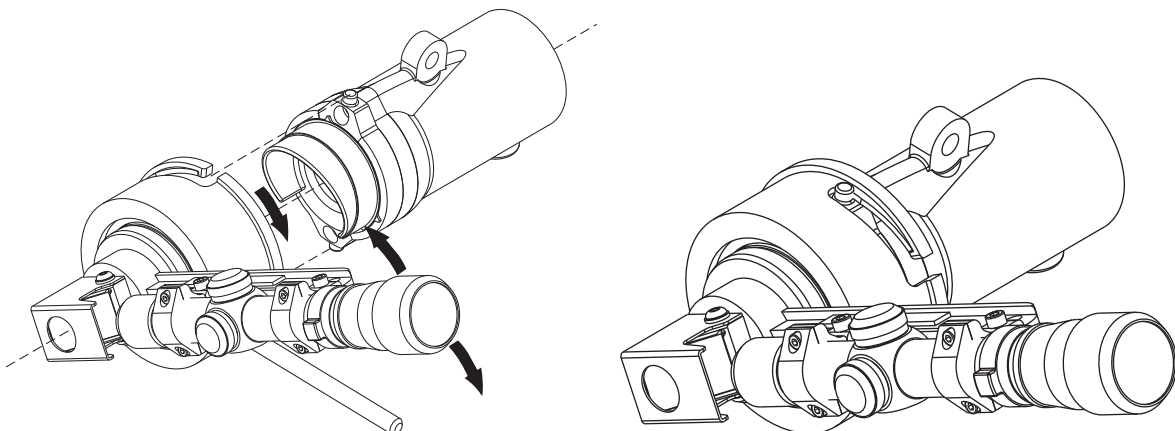

10. Align Excel using assembly adjustment screws. Adjust so cross-hairs viewed through alignment telescope are centered on window of the other Excel unit.

View image with eye placed approximately 3 inches from viewfinder. Use viewing position that ensures full circular view is in sight.

An ellipse appears when slightly off axis. Do not adjust using telescope's elevation and windage adjusters - they are factory set

Iteratively tighten and loosen each pair of adjustment screws sequentially in horizontal and vertical directions until setting is correct. When correctly adjusted, tighten both adjustment screws simultaneously

Check alignment and repeat steps as necessary

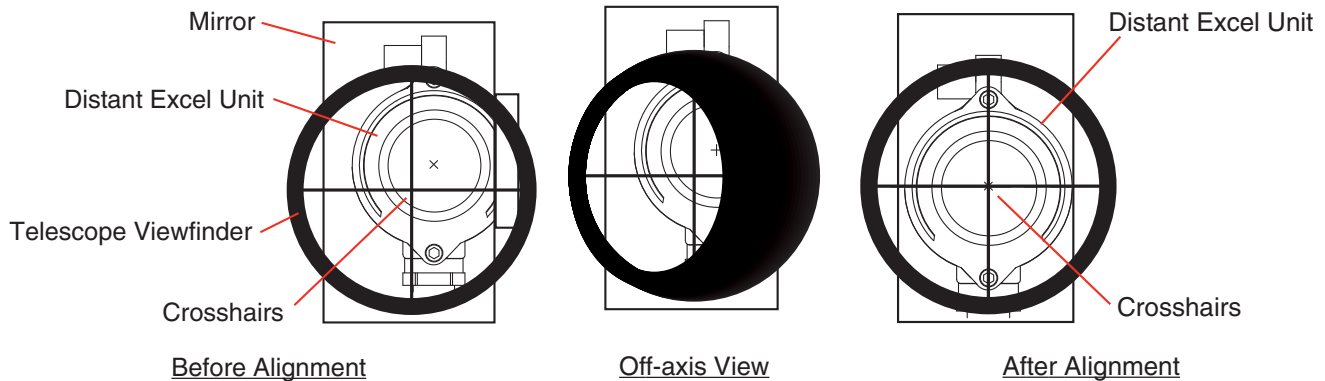

Align Excel using XNX to determine optimal performance. As alignment is performed, XNX display indicates signal strength in a bar graph.

- From the XNX Calibrate menu, perform careful alignment of Excel, insuring signal strength bar graph reaches or exceeds 1.00 as shown on display.



- Use fine adjustments to adjust the Excel alignment until signal strength bar reaches or exceeds 1.00.

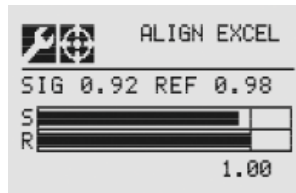

- Once completed, to exit Align Excel Mode and perform Zero Calibration

Zero Calibration

Before Zero Cal, ensure area is free of combustible gases

- From the Calibration menu, select the Gas Calibration option.



- Perform a zero calibration. When concentration values are stable, select for XNX to calculate the zero adjustment .



3. Select to return to the Gas Calibration menu. If the zero calibration was successful, the transmitter will display the Zero Passed screen

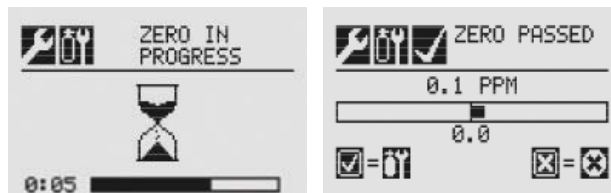

4. Once successfully Zero calibrated, the XNX will continue to the Span Calibration procedure. Span Calibration is not required for the Searchline Excel.

Unit Alignment and Zero Cal with SHC-1 Handheld Interrogator

Use same procedure for aligning transmitter and receiver

1. Loosen clamp nuts and adjustment clamp screws on transmitter and receiver until they move freely in all axes

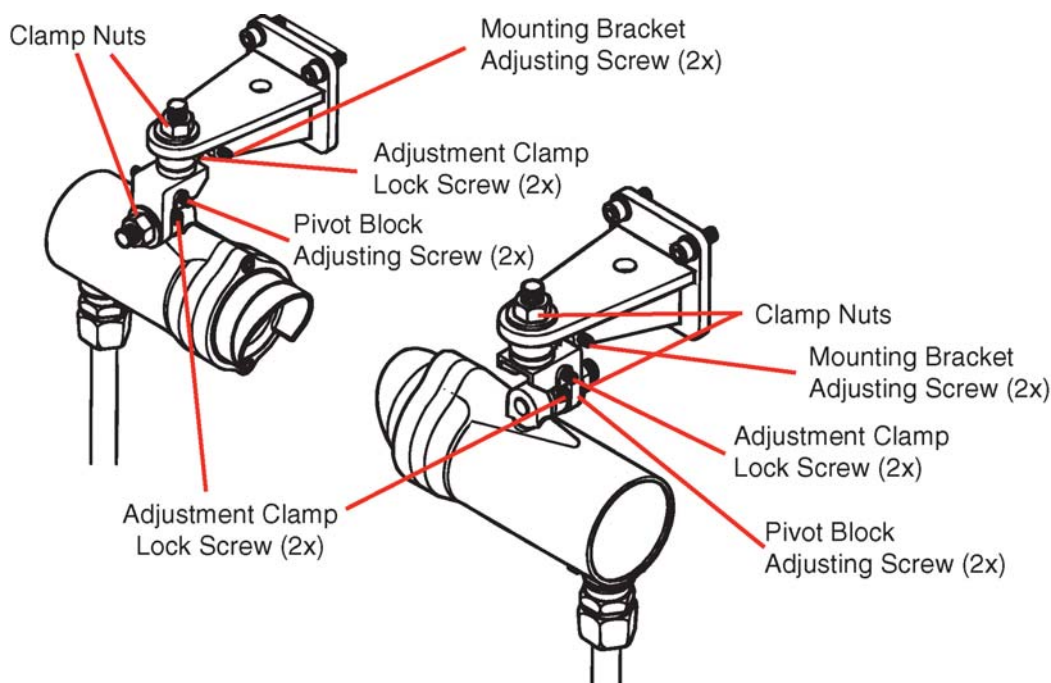

2. Point transmitter and receiver so they face each other
3. Tighten clamp nuts and adjustment clamp screws on each unit until they cannot be moved by hand

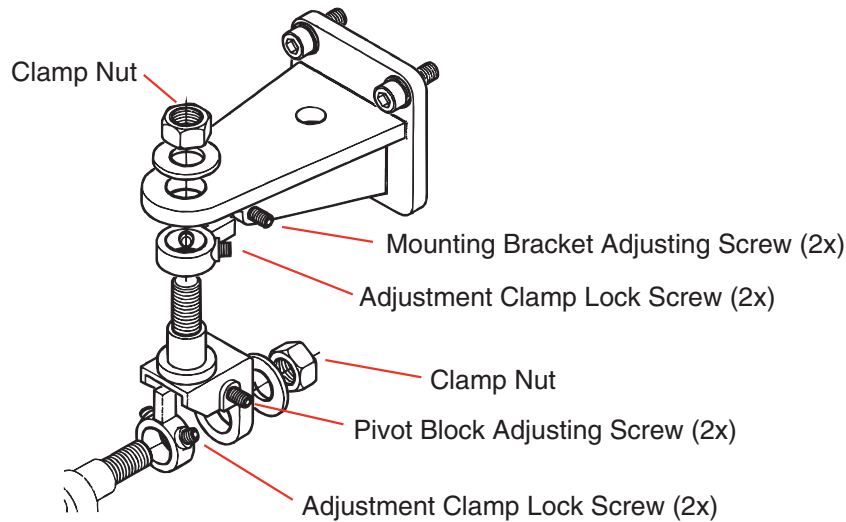

4. Clamp nuts and screws should not need further tightening
5. Additional tightening will affect fine adjustment and should be avoided
6. Unit can still be moved by adjustment screws
7. Before adjustment check front face of units to determine telescope type. Trident-type Excel units have three small pads, non-Trident types do not.

Pads provide contact points for alignment telescope assembly datum insures accurate telescope attachment so alignment is precise.

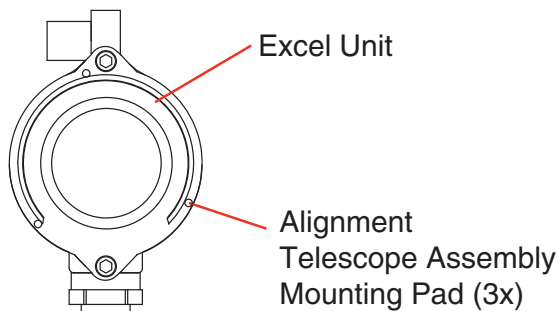

Trident-type

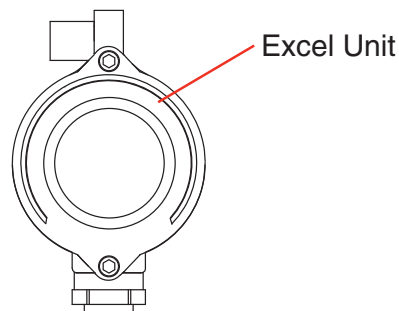

Non-trident-type

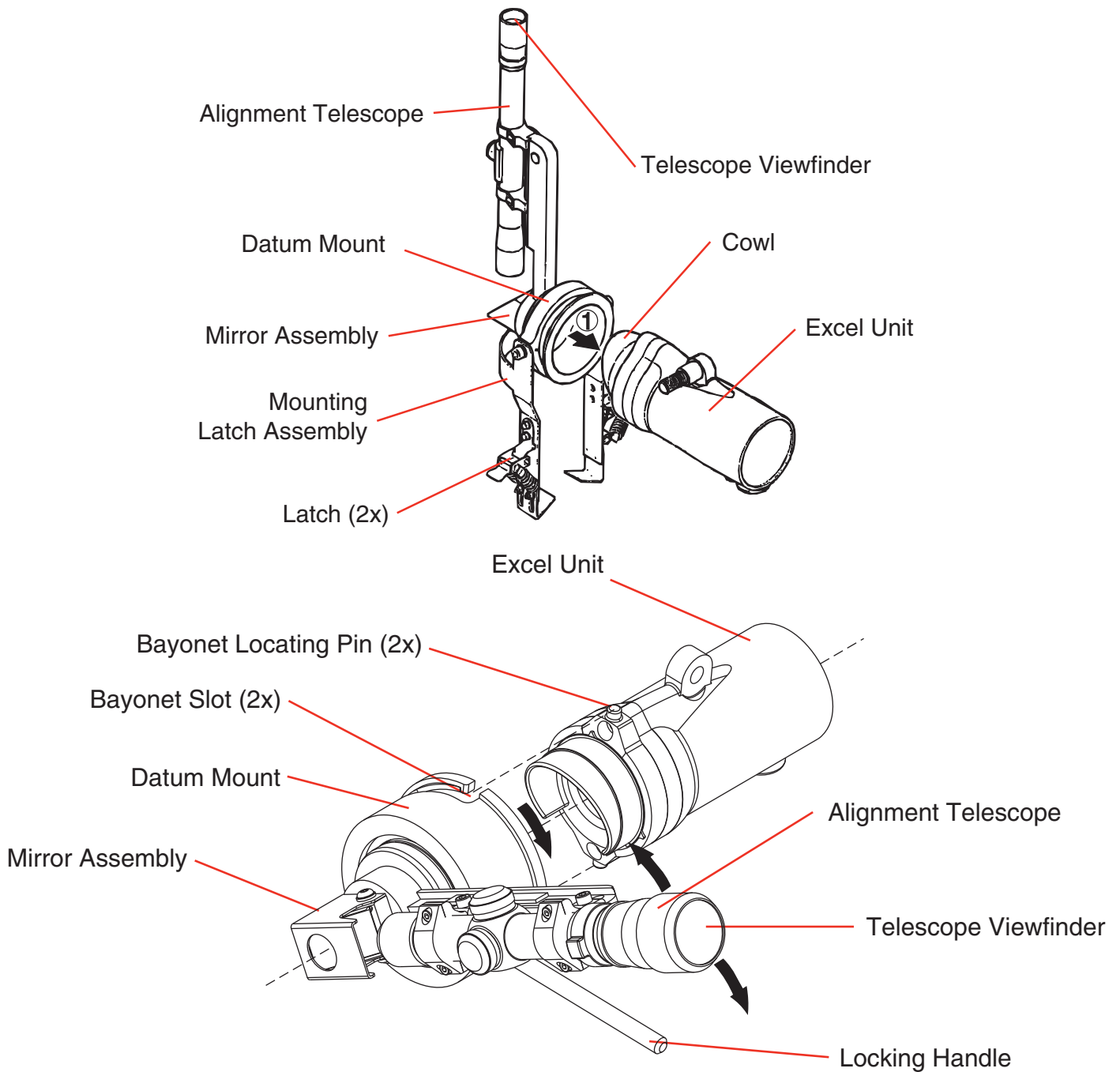

8. Latch-style assembly consists of
- Telescope and mirror
 - Latching mechanism
 - Can be used with Trident or non-Trident units

Fit datum mount of alignment telescope securely over unit cowl so mirror face is visible. Ensure datum mount is fully seated on cowl. Undo latches on telescope’s mounting latch assembly and rotate assembly so parallel support bar fits underneath unit as indicated by arrow 2. Locate latch mounting hooks behind back of unit. Rotate telescope to a comfortable viewing position, then secure latches as indicated by arrow 3.

Proceed with alignment

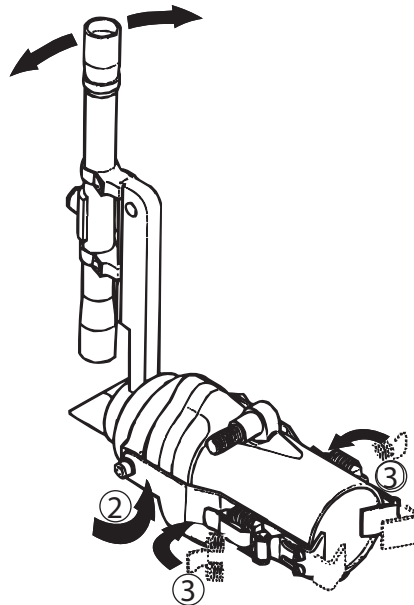

9. Bayonet-style Assembly only used with Trident-type Excel units - assembly consists of

- Telescope and mirror
- Datum mount
- Bayonet attachment
- Datum mount handle for rotating and locking assembly

Align telescope's two bayonet slots with two locating pins on unit cowl and seat telescope mount fully on cowl. Rotate telescope to a comfortable viewing position and hold it in that position. Use mount's locking handle to rotate bayonet fitting in a clockwise direction until securely locked on cowl.

Proceed with alignment

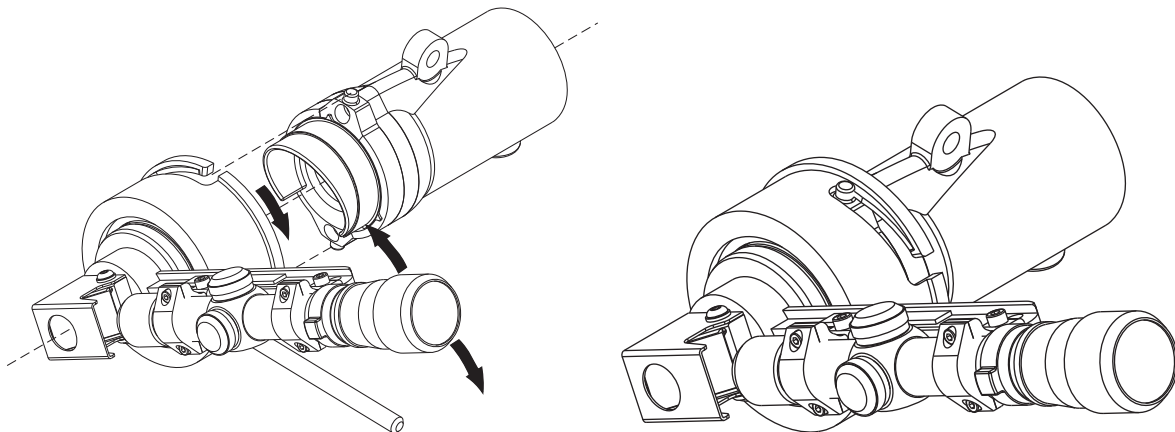

10. Align Excel using assembly adjustment screws. Adjust so cross-hairs viewed through alignment telescope are centered on window of the other Excel unit.

View image with eye placed approximately 3 inches from viewfinder. Use viewing position that ensures full circular view is in sight.

An ellipse appears when slightly off axis. Do not adjust using telescope's elevation and windage adjusters - they are factory set

Iteratively tighten and loosen each pair of adjustment screws sequentially in horizontal and vertical directions until setting is correct. When correctly adjusted, tighten both adjustment screws simultaneously

Check alignment and repeat steps as necessary

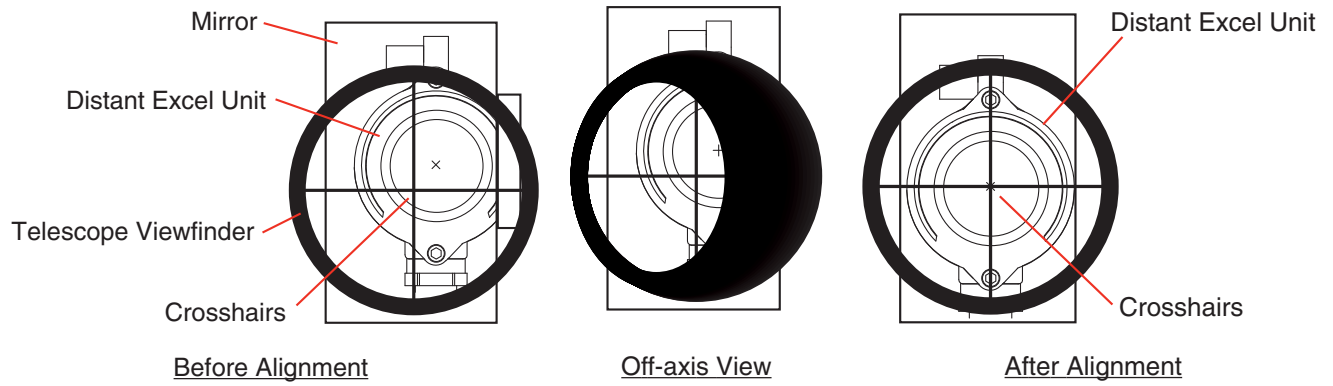

1. Connect SHC1 Handheld Interrogator to Excel via DX100(M) Junction Box via its IS socket

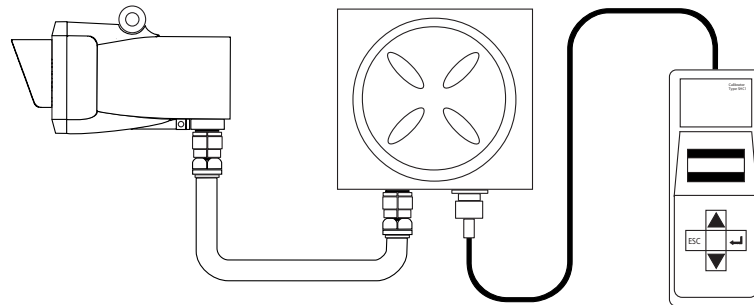

Press \leftarrow and hold 3 sec to power
 Press \leftarrow and **esc** together to power off
 Unit powers off automatically after 10 min

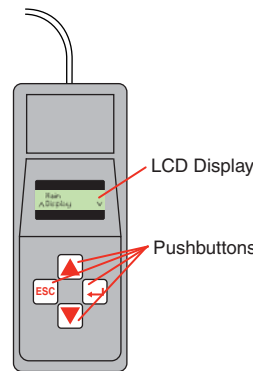

2. Apply power to transmitter and receiver
3. If not already connected, connect SHC-1, press \leftarrow to power on. Check that the SHC-1 is in Excel mode.

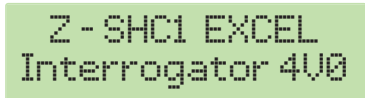

After five seconds the display shows



4. Press \blacktriangledown to move through the menu to the Calibrate Menu; display shows



5. Select "Install" from the Calibrate menu and press \leftarrow , the System Type screen is displayed

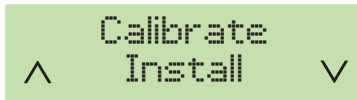

The second line shows the current gas detector type: Short Range 5 - 40m (15 - 130ft), Medium Range 20 - 120m (65 - 390ft) or Long Range 20 - 200m (65 - 650ft)

- Press **↵**, the Current Path Length *in meters* is displayed. Verify actual path distance (in meters) between transmitter and receiver.

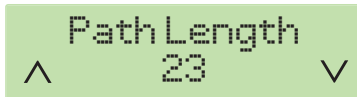

Minimum and maximum path length entry options for each gas detector are:

Gas Detector Type	Minimum Range	Maximum Range	Step Size
Short Range	4m / 16ft	40m / 131ft	1m / 3ft
Medium Range	20m / 66ft	120m / 394ft	1m / 3ft
Long Range	20m / 66ft	200m / 656ft	1m / 3ft

- When finished press Enter. Self-test routine is started display shows following message:

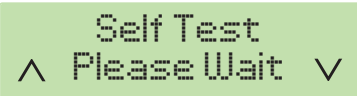

When test is successful following message is displayed:

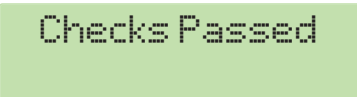

The screen then changes to show a display similar to the following.

The first line of the display shows the magnitude of the current signal level as a horizontal bar graph - SIG:

The second line of the display shows the magnitude of the current target signal level as a horizontal bar graph - TGT:



NOTE

- The overall objective of alignment is to maximize the SIG level. Maximized SIG corresponds to optimal alignment.
- The Instrument Assisted Alignment (IAA) system only allows Excel to be initialized if the SIG level is greater than or equal to the TGT level when Enter is pressed.
- The smallest TGT signal level that is initially set will be equivalent to 70% (0.700) of the signal expected for the installation's path length.
- The TGT level will increase gradually if the current SIG level is larger than the TGT level.

The TGT signal level only ever increases. If the current SIG level falls below the TGT level, TGT will remain at its previous highest value. In order to initialize the gas detector the SIG level must be brought back above the TGT level.

- e) If the SIG level is less than 50% of the expected level, the bar graphs are not displayed. Instead both SIG and TGT levels are displayed as numbers.
8. (10) Now carry out one of the procedures described under Options.

Options

The next procedure to be followed depends on the type of alignment telescope and mounting initially used to set up the Excel gas detector.

Bayonet-style telescope assembly

If this type of alignment telescope was used with a Trident-type Excel gas detector, there is no need to further optimize the alignment using the SHC1 Handheld Interrogator.

When the SIG and TGT bar graphs are displayed on the SHC1 screen, SIG will always be greater than TGT and installation can proceed to the next stage by pressing Enter and following step 12.

Latch-style telescope assembly

If this type of alignment telescope was used with a Trident-type Excel gas detector, there is no need to further optimize the alignment using the SHC1 Handheld Interrogator.

If this type of alignment telescope was used with a non-Trident Excel it may be necessary to further optimize the alignment in the following way in order to achieve best performance.

- a) After the SIG and TGT bar graphs are displayed on the SHC1 screen as previously described, let the TGT level reach its initial maximum by waiting for approximately 10 seconds.
During this time the TGT level will move up towards the current SIG level.
- b) While watching the SIG level closely, make a small mechanical adjustment in either the horizontal or vertical alignment and note whether the SIG level goes up or down.
- c) If the SIG level goes up, make another small mechanical adjustment in the same direction as before.
- d) If the SIG level goes down, change the direction of adjustment. Maximize the SIG level by making small adjustments in only one plane at a time.
- e) When the SIG level has been maximized in one plane, make small adjustments in the other plane until SIG has been maximized in this plane.
- f) Repeat steps (b) to (e) until the SIG level has been maximized in both planes. At this point, SIG must be bigger than the initial TGT level and any adjustment either side of the current alignment must result in a reduction in signal level. If not, repeat steps (b) to (e) until these requirements have been met.
- g) Lock off the alignment by placing a hex (Allen) key in the pair of grub-screws which control adjustment in a particular plane and simultaneously rotating them in opposite directions.
- h) Repeat this for the other pair of grub-screws.
- i) Press Enter and the signal levels are checked. With the SIG level is greater than the TGT level, the signal check should pass and the screen should display the following message: Signals OK



Signals OK

Notes:

- 1. If SIG is less than the TGT value the following message is displayed:



Low Signal
Enter to Retry

- 2. If SIG is more than the TGT value the screen shows the bar graph screen again.

```
SIG: ■  
TGT: ■
```

(12) When the following message is displayed press Enter:

```
Signals OK
```

Zero Calibration

The display changes to show the following instruction:

```
Ensure Zero Gas  
Then Press Enter
```

If zero reading in ambient air cannot be guaranteed, fit gassing cover over weather protection and apply instrument air at one liter/minute for 30 sec.

10. Press to begin Zero Cal; display then shows

```
Processing Data  
Please Wait...
```

11. After 10 sec display shows; Zero is now set.

```
Zero Calibration  
OK
```

12. Once Zero Cal is complete, after a few seconds, display shows.

```
Installation  
Complete
```

After a few seconds, the display shows:

```
Press Enter to  
Release 4-20
```

Releases analog output from 2mA (inhibit signal) to normal operation (4mA)

13. Press and hold for 3 sec, display shows

```
4-20 Released
```

The display then changes to show the Calibrate menu. The Searchline Excel gas detector is now live.

```
Calibrate  
^ Install v
```



IAQPoint

IAQPoint Calibration Procedure

Setting the Sensor Zero

This option allows users to calibrate the sensor Zero.



Never calibrate the sensor Zero with ambient air. Always use Nitrogen (N₂). Make sure to release the gas to the sensor for at least 10 minutes before beginning and continue throughout.

- Before starting the calibration (using the programming menus), connect the regulator to the gas cylinder.
- Adjust the flow rate to 0.1 L/min.
- Open the rubber cap on the IAQPoint calibration port and connect the tubing from the regulator to the sensor, as shown.
- Let the gas flow for at least 10 minutes before starting the calibration.
- Scroll to the CO₂ Set Zero screen and press Enter to select.

```
* Menu *
CO2 Set Zero
```

- The next screen requests confirmation; Use the Up or Down buttons to display YES and press Enter to confirm. (If there is no confirmation within 32 seconds, the calibration is automatically canceled and display returns to the main menu option.)

```
CO2 Set Zero
YES
```

A confirmation screen is briefly displayed and the zero calibration begins.

```
* Menu *
In Calib
```

A success or failure message is displayed and the screen returns to the main menu option.

```
CO2 Set Zero
SUCCESS
```

Calibrating the CO₂ Sensor

This option allows users to calibrate the sensor's span.

Note:

When calibrating a duct mounted unit, the unit must be removed from its base to ensure proper calibration.

- Before starting the calibration (using the programming menus), connect the regulator to the gas cylinder.
- Adjust the flow rate to 0.1 L/min.(for the 2000 ppm range)
- Connect the tubing from the regulator to the sensor, as shown in the image at left.



Start exposing the sensor to the calibration gas at least 10 minutes before starting and throughout the calibration process.

- Let the gas flow for at least 10 minutes before starting the calibration.
- Scroll to the "CO₂ Set Span" main menu option and press Enter to select.

```
* Menu *  
CO2 Set Span
```

- The next screen allows you to specify the span calibration gas concentration value.

```
Set Span Gas  
2000
```

- Use the Up or Down buttons to increase or decrease the value and press Enter to select.

```
CO2 Set Span  
YES
```

- The next screen requests confirmation; press Enter to confirm and the screen displays the following message. (If there is no confirmation within 32 seconds, the calibration is automatically canceled and display returns to the main menu option)

```
* Menu *  
In Calib
```

- A success or failure message is displayed and the screen returns to the main menu option.

```
CO2 Set Span  
SUCCESS
```



Honeywell

Calibration Guide

IAQPoint2

IAQPoint2 Calibration Procedure

Calibrating the CO₂ Sensor

This option allows users to calibrate the sensor's span.

Note:

When calibrating a duct mounted unit, the unit must be removed from its base to ensure proper calibration.

1. Enter the level 2 password. By default, 2967
2. Navigate to Calibrate > Calibrate Gas. This screen will flash every second to indicate calibration mode
3. A message may be displayed indicating that Automatic Baseline Correction (ABC) is enabled and calibration is not possible. If ABC is not desired, it can be disabled in the Configure > Configure Outputs > Auto Baseline menu
4. Connect a cylinder of a test gas of known concentration to a 0.5lpm regulator
5. Connect the regulator's tube into the calibration port on the side of the IAQPoint2 monitor
6. For Duct Mount version, remove display assembly portion from duct tube before attempting calibration
7. The top line of the display shows the mode of the CO₂ sensor. Verify that this is "normal" and not some other message
8. The second line of the display shows the current concentration. Verify that this shows a reasonable number. Since the calibration gas flow has not yet been started, this should show an ambient CO₂ concentration. It is normally greater than 500 ppm in a room
9. Open the regulator's valve to start the flow of gas
10. Wait three minutes for test gas to purge all of the ambient air out of the sensor
11. Verify that the concentration reading stabilizes to match the cylinder CO₂ concentration within ± 200 ppm
12. Verify that the "Target" concentration matches the concentration of the cylinder of test gas. If pure nitrogen is used, this should be zero. If needed, enter the correct concentration by pressing [Target]
13. Press [Base Cal Now]
14. The mode display should show "in base cal" for about ten seconds
15. Verify that the mode display shows "base cal pass"
16. Verify that the concentration reading matches the target concentration ± 30 ppm
17. Turn off the valve on the regulator
18. Verify that the test gas concentration rises to a reasonable value after about one minute, reflecting the ambient concentration
19. Press [✓] and navigate back to the main menu. The main display may show a fault for up to four seconds when exiting calibration mode. This is normal and is not an indication of trouble
20. Disconnect the regulator from the gas cylinder.
21. **IMPORTANT:** For duct mount models, re-connect display to duct tube. Confirm calibration port plug is reinstalled. If this is step is neglected, the sensor's sampling

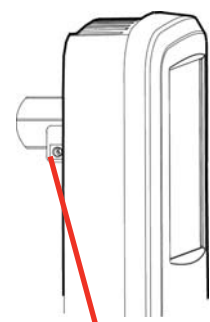

Calibration Port

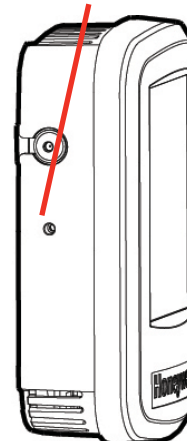

of duct CO2 concentration may be contaminated by ambient CO2 levels.

Calibrating the VOC Sensor

- The VOC sensor automatically calibrates itself over a period of about a week
- The automatic calibration requires that the VOC sensor be exposed to fresh air for at least one hour of each day
- No manual calibration for VOCs is possible
- A bump test of wall-mount models may be performed by simply breathing on IAQPoint2

Calibrating the Temperature Sensor

1. Determine the true temperature of the space by use of a reference thermometer
2. Enter the level 2 password. By default, 2967
3. Navigate to Calibrate > Calibrate Temperature
4. Press [Target] to navigate to “Set Tgt Temp”. Enter the temperature reported by the reference thermometer
5. Press [Calibrate Offset]
6. Verify that the message “in base cal” is displayed. This lasts about two seconds
7. Verify that the message “Calibration Done” is displayed
8. Press [X]
9. Verify that the Current temperature agrees with the reference thermometer. Note that this screen does not automatically update. If desired, an update can be forced by exiting and re-entering this screen
10. If desired, the factory calibration may be restored by pressing [Revert to Factory Cal]
11. When satisfied, with the temperature reading, navigate to the main screen



Calibrating the Humidity Sensor

1. Determine the true rH level by use of a reference hygrometer
2. Enter the level 2 password. By default, this is 2967
3. Navigate to Calibrate > Calibrate rH
4. Press [Target] to navigate to “Set Target rH”. Enter the relative humidity reported by the reference instrument
5. Press [Calibrate Offset]
6. Verify that the message “in base cal” is displayed. This lasts about two seconds
7. Verify that the message “Calibration Done” is displayed.
8. Press [X]
9. Verify that the Current rH agrees with the reference hygrometer. Note that this screen does not automatically update. If desired, an update can be forced by exiting and re-entering this screen
10. If desired, the factory calibration may be restored by pressing [Revert to Factory Cal]
11. When satisfied, with the humidity reading, navigate to the main screen.



Calibrating mA Output

The monitor's mA output for each of three channels can be calibrated to match that of a site's external HVAC equipment

- Channel 1 measures gas levels
- Channel 2 can be configured to measure Gas or Temperature
- Channel 3 measures humidity

1. Select desired channel
2. Select mA output level
3. Increase or decrease by pressing +/- 10 for course adjustment or +/- 1 for fine adjustment
4. Press [✓]

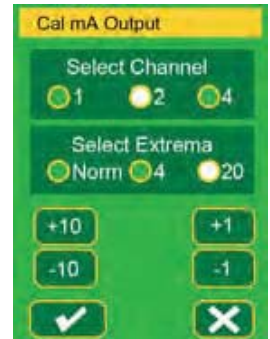



IR-F9 / AirScan iR

IR-F9-RXX/AirScan iR Calibration Procedure

General Information

There are only two pots on the pre-amp that are used for calibrations. All other pots are factory set and must never be adjusted. They can only be properly adjusted at the factory. Refer to the Manning AirScan™iR instruction manual for more in-depth calibration procedure details.

Zero Calibration

1. Press and hold both “zero” (S1) and “span (S2) buttons simultaneously for one second or until the “system” LED begins to blink slowly. Refer to figure 11 for switch location.

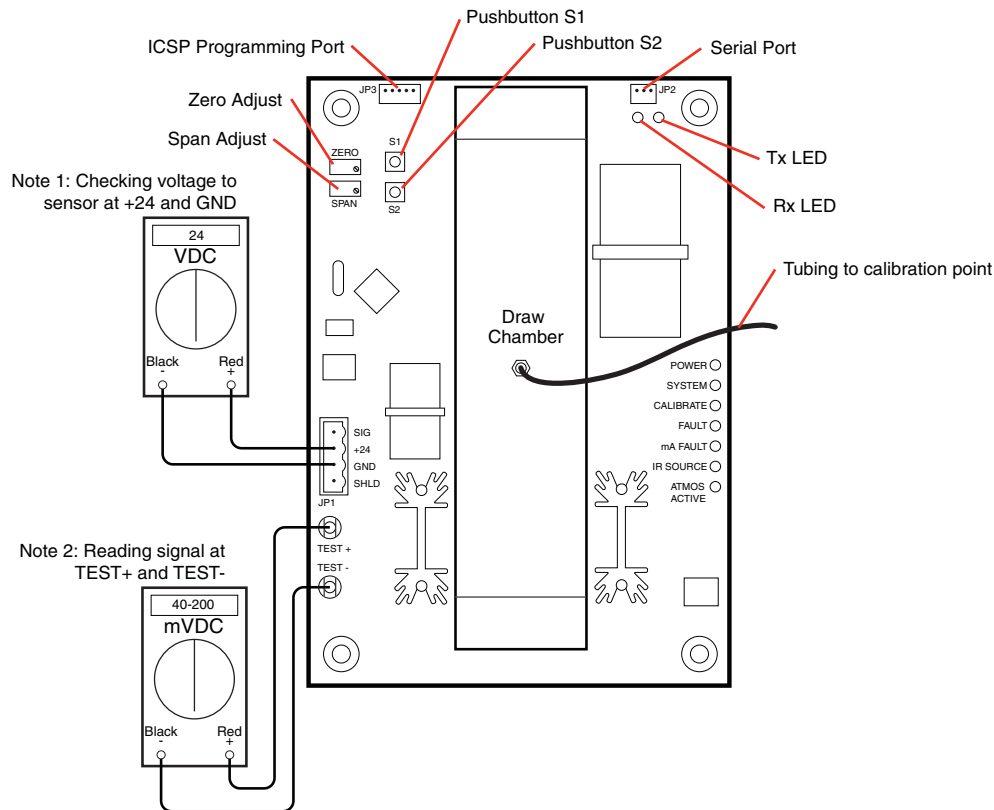

Figure 11. IR-F9 Switch Locations

2. If calibrating a CO2 unit or in a high-background environment, apply pure nitrogen (N2) into the calibration port at a rate of 1.0 L/min. for at least 45 seconds (OR until output signal is within $\pm .02$ mA of signal deviation/change).
3. Press and hold “zero” button (S1) for approximately 1 second or until the yellow “calibrate” LED is continuous ON.
4. When yellow calibration LED is continuous ON, release “zero” button. The “calibrate” LED will turn off and the unit will be zeroed.
5. Parameters are now programmed into memory.
6. Place multi-meter leads on Test(+) and Test(—) and ensure the output is steadily resting between 3.9 to 4.1mA (39.0 to 41.0mV).
If this isn't the case, initiate the auto “zero” procedure once again.
7. Press and hold both “zero” (S1) and “span” (S2) buttons simultaneously for one second or until the yellow “system” LED will be ON solid.
8. End of zero procedure.

Span Calibration

This procedure sets the “span” or concentration level that would depict a 20mA reading for full-scale target gas on the 4/20mA output.

NOTE: This procedure should only be performed if the zero procedures are successfully completed.

1. If not already in place, set meter to mV DC and place meter leads on Test(+) and Test(—) respectively.
2. Press and hold “span” button (S2) for 1 second or more until the yellow “calibrate” LED blinks fast and the yellow “system” LED is blinking slowly (see the following example). See Figure 11 for switch and potentiometer location.
3. Ensure the output rests between 3.9 and 4.1mA (39.0 to 41.0mV).
4. If this is not the case, perform the “zero” procedure again.
5. Once the output is within the required range, apply full-scale target gas into the calibration port at a rate of 1.0 L/min for 1 minute.

If the signal is 20mA (200mV) or greater, adjust the “span” potentiometer counter-clockwise until the signal is near 20mA (200mV).

If the output signal is less than 20mA (200mV), adjust the “span” potentiometer clockwise until the signal is near 20mA (200mV).

Because there is a slight delay in potentiometer movement, make small adjustments and wait for the output to change because adjustment response is delayed between source pulses.

6. Wait until the output signal has stabilized to within $\pm .02$ mA (0.2mV) of signal deviation/change.
7. Adjust the “span” potentiometer again until the output reads around 20 mA.
8. Press and hold “span” button (S2) for one second or more until the yellow “calibrate” LED turns off.



Honeywell

Calibration Guide

Midas[®] Gas Detector

Midas Calibration Procedure

Zero Calibration - Hardware Setup

- Connect 1LPM regulator to Zero Air grade gas cylinder
- Connect 'Tee' to regulator
- Connect open end of 'Tee' to Midas® inlet port
- Be sure Midas® in "Zero Calibration" mode

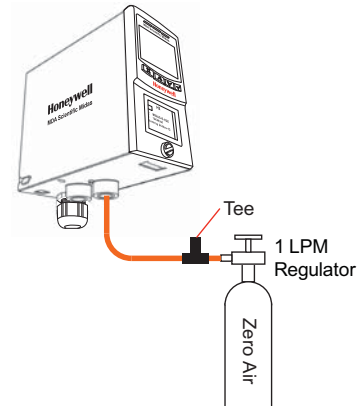

WARNING

NEVER force a sample into Midas, unit damage may result.





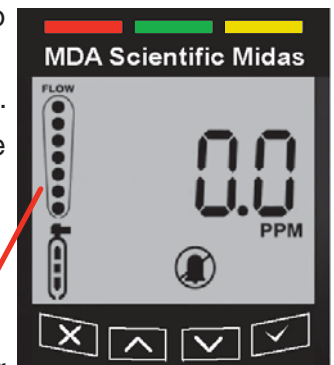

Zero Calibration

1. Use '▲' or '▼' to select zero calibration '0CAL' submenu and press '✓' to accept.
2. Zero calibration icon starts flashing for user to prepare to apply zero gas.
3. Inhibit  icon is also displayed indicating that no alarm outputs will be generated during this process.
4. Press '✓' to confirm when ready and the icon goes steady.
5. Apply zero gas (or ambient air).
6. Dots on the left of the display indicate progress to a successful zero.
7. Display will show the zero gas reading and if measured to be stable for an appropriate period of time will display 'PASS'.
8. If zero calibration is unsuccessful, display will show an error code (see table below).
9. Press '✓' to exit.
10. Press '▲' or '▼' to select another submenu.
11. Press 'X' to return to set-up, calibration and test menu selection.
12. Press 'X' again to return to normal operation.



NOTE

The change in the gas bottle icon's contents gives an indication as to the relative stability of the gas reading. The arrows and bars inside the cylinder indicate whether it is rising or falling as appropriate (see table at right).

Calibration Stability Icons	
	Stable
	Over - Range
	Unstable - Rising
	Unstable - Flat
	Unstable - Falling
	Under - Range

Code	Code Meaning
PASS	Successful Calibration
FL:0H	Zero Calibration Timeout – Over Range
FL:0L	Zero Calibration Timeout – Under Range
FL:0U	Zero Calibration Timeout – Unstable
FL:SH	Span Calibration Timeout – Over Range
FL:SL	Span Calibration Timeout – Under Range
FL:SU	Span Calibration Timeout – Unstable

Bump Test/Calibration Setup

Option 1

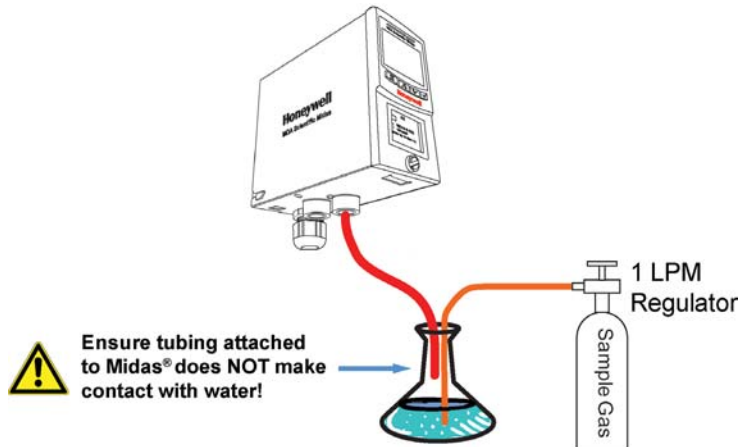

Option 2

1. Fill ½ gas bag with humidified sample gas —————
2. Remove bubbler and fill remainder of gas bag with dry sample gas —————
3. Enter “Bump Test” or “Calibration” menu
4. Attach Midas inlet port to gas bag

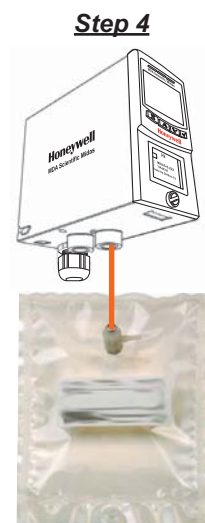
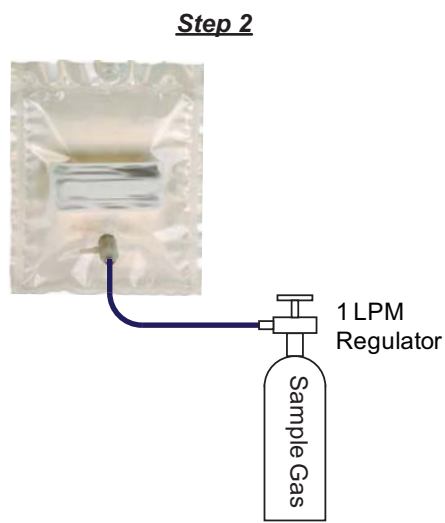
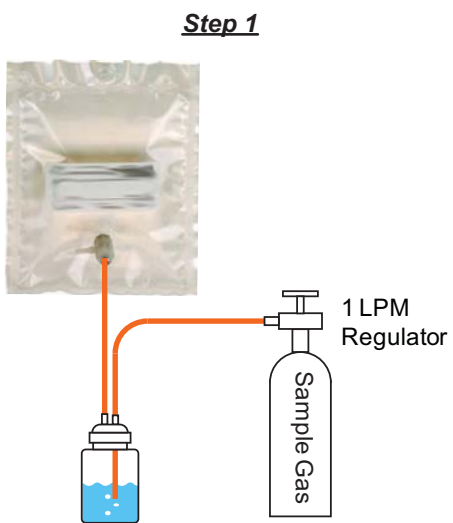







Span Calibration

1. Use '▲' or '▼' to select the span calibration 'SPAN' submenu and press '✓' to accept.
2. Span calibration icon starts flashing for user to prepare to apply span gas.
3. Inhibit  icon is also displayed indicating that no alarm outputs will be generated during this process.
4. Use '▲' or '▼' to select to select the gas ID code of calibration gas (for multi gas ID sensor cartridges only) and press '✓' to accept.
5. Use '▲' or '▼' to select if humidified 'HUM' or dry 'drY' calibration gas is being used.
6. Use '▲' or '▼' to change the value to the concentration of span calibration gas being used.
7. Press '✓' to confirm when ready and the icon goes steady.
8. Apply span gas.
9. The dots on the left of the display indicate progress to a successful span.
10. Display will show the span gas reading and if measured to be stable for an appropriate period of time will display 'PASS'.
11. If span calibration is unsuccessful, display will show an error code (see below).
12. Press '✓' to exit.
13. 13. Press '▲' or '▼' to select another submenu.
14. Press 'X' to return to set-up, calibration and test menu selection.
15. Press 'X' again to return to normal operation

NOTE

The change in the gas bottle icon's contents gives an indication as to the relative stability of the gas reading. Arrows and bars inside the cylinder indicate whether it is rising or falling as appropriate (see table below).

Code	Code Meaning
PASS	Successful Calibration
FL:0H	Zero Calibration Timeout – Over Range
FL:0L	Zero Calibration Timeout – Under Range
FL:0U	Zero Calibration Timeout – Unstable
FL:SH	Span Calibration Timeout – Over Range
FL:SL	Span Calibration Timeout – Under Range
FL:SU	Span Calibration Timeout – Unstable

Calibration Stability Icons	
	Stable
	Over - Range
	Unstable - Rising
	Unstable - Flat
	Unstable - Falling
	Under - Range

Flow Calibration

Flow calibration is to define 3 points to allow built-in transducer automatically perform flow compensations:

- Baseline (zero flow)
- Setpoint 1 (500cc)
- Setpoint 2 (650cc)

1. Connect mass flow meter to Midas inlet port.

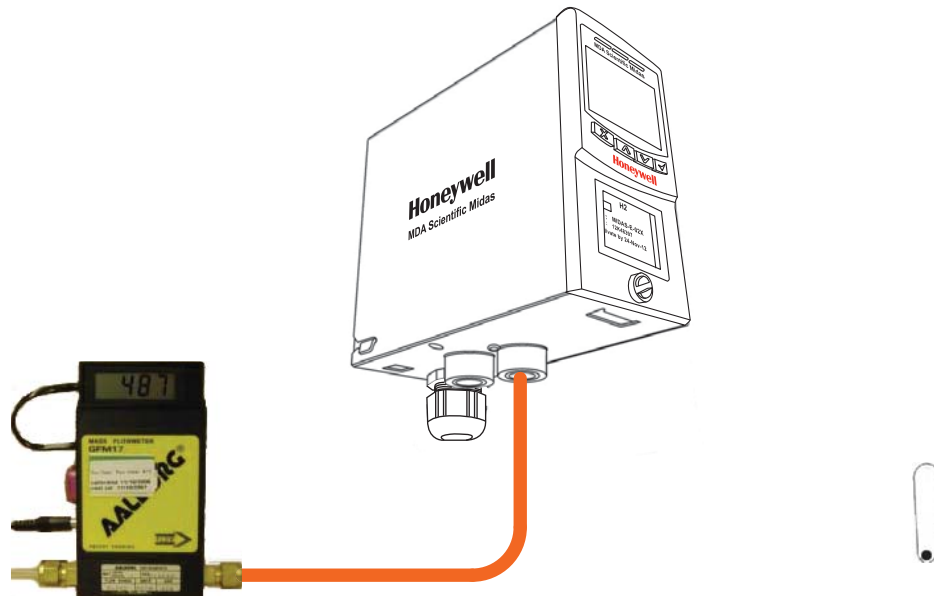

2. Establish Baseline

- a. Use '▲' or '▼' to select flow calibration 'iFLOW' sub menu
 - Press '✓' to accept
- b. Flow icon with dot at bottom flashes to indicate unit is ready to read zero flow offset
- c. Inhibit icon also displayed
 - Indicates no alarm outputs will be generated during process
- d. Press '✓' to confirm
 - Icon goes to steady
 - Unit counts down from 10 as zero flow offset is read



3. Establish Setpoint 1

- e. Flashing flow icon displayed
 - Dot approx mid-icon – indicates Setpoint 1 flow
 - 500cc/min
- f. Press '▲' or '▼' to adjust external flow meter to proper Setpoint 1 value
 - Reading must be ± 50 cc/min of target to be accepted
- g. Press '✓' to confirm
 - Target value flashes
- h. Press '▲' or '▼' to enter actual value as read by external flow meter
 - Hold button to increase increment speed



- i. Press '✓' to confirm
 - Icon goes to steady
 - Unit counts down from 10 as Setpoint 1 value is read
4. Establish Setpoint 2
 - j. Flashing flow icon displayed
 - Dot near top of icon – indicates Setpoint 2 flow 650cc/min
 - k. Press '▲' or '▼' to adjust external flow meter to proper Setpoint 2 value
 - Reading must be ± 50 cc/min of target to be accepted
 - l. Press '✓' to confirm
 - Target value flashes
 - m. Press '▲' or '▼' to enter actual value as read by external flow meter
 - Hold button to increase increment speed
 - n. Press '✓' to confirm
 - Icon goes to steady
 - Unit counts down from 10 as Setpoint 2 value is read
5. Save/Update
 - o. If successful UPdt or SAVe displayed
 - p. Flow calibration is complete
6. Press '▲' or '▼' to select another submenu
7. Press 'X' to return to setup, calibration and test menu



1. Flow Calibration Web Page
 - a. On-screen instructions supplied
 - Connect flow meter to Sample line
 - Click "Start"
 - Click "Next" for baseline
 - Click "Next" for Setpoint #1
 - Click "Increase" or "Decrease" to match (+/- 10%) of Setpoint value
 - Click "Next" for Setpoint #2
 - Click "Increase" or "Decrease" to match (+/- 10%) of Setpoint value
 - Click "Finished"

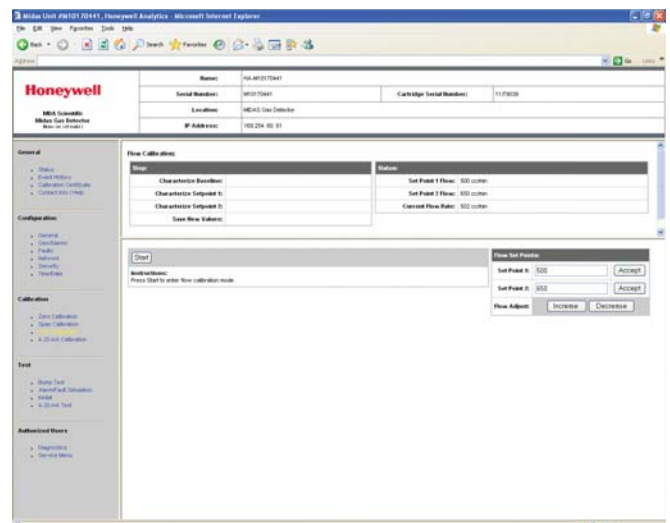



Searchpoint Optima Plus

Searchpoint Optima Plus Calibration Procedure

Searchpoint Optima Plus is supplied factory calibrated for a particular hydrocarbon gas (approximately 100 different gas calibrations are currently available). Properly installed and maintained, Optima Plus does not require routine calibration. This operational benefit is made possible by the inherent stability of the IR absorption process and the fully compensated optical configuration used.

In order to maintain confidence in the continued correct operation of fielded Optima Plus units it is recommended that a functional gas test is incorporated into the planned maintenance procedure for the unit. In most applications and installations, a planned maintenance / service interval of 1 year is appropriate, although this will depend upon site conditions and requirements. EN50073 and national regulations should be observed.

Where site operating procedures or regulations require routine calibration of gas detectors, this is possible using the SHC-1 Handheld Interrogator and the gassing cover.

Care needs to be taken in order to ensure that routine field calibrations do not reduce the calibration accuracy compared to the original factory calibration. (Factory calibration is performed in more controlled conditions than are readily achievable in the field.)

Searchpoint Optima Plus with XNX

Equipment Required:

- Gassing Cover
 - Instrument Air (if a zero in ambient air cannot be guaranteed)
 - Calibration Span Gas (i.e. 2.5% V/V methane for 50% LEL output or 2.2% V/V for 50% UEG)
1. From the Calibration menu, select the Gas Calibration option.



2. Perform a zero calibration. When concentration values are stable, select for XNX to calculate the zero adjustment .

Sensor Reading
at Current Settings

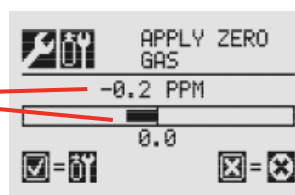

3. Select to return to the Gas Calibration menu. If the zero calibration was successful, the transmitter will display the Zero Passed screen

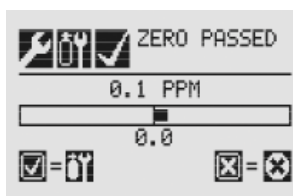

4. Begin the span calibration by entering the concentration value of the calibration gas: Select to choose the first digit. Use +/- to increment/decrement values. Select to accept the value and move to the next digit. Use calibration cover P/N 2108B0272 to perform span calibration at a flow regulator of 1 LPM. (If a span calibration is not required, select to return to the calibration menu.)

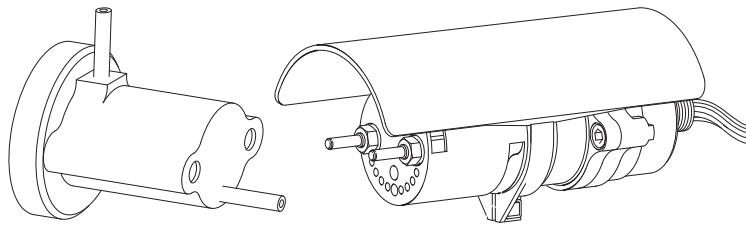

5. Continue until all three digits have been entered.

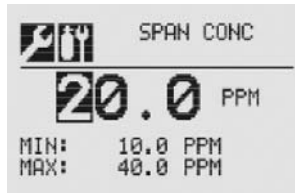

6. Apply the span gas. When concentration values are stable, select to calculate the span adjustment. This process also determines if the sensor is within range to accurately detect the target gas.

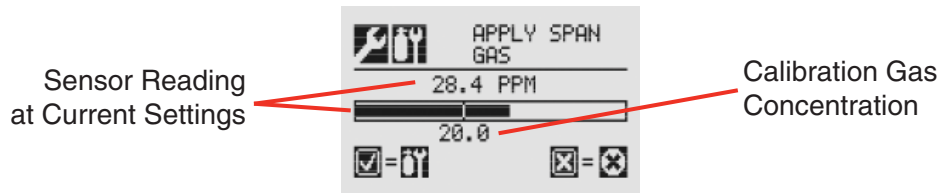

7. Select to return to the Gas Calibration menu. If the calibration is not successful, the Span Failed screen will be displayed.

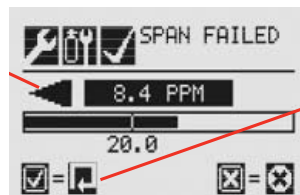

Select to return to the Span Concentration screen to repeat the span calibration.

Select to exit Span Calibration and return to main Calibrate screen. If Span Calibration is exited, the previous calibration values will be used. Select to return to the Span Concentration screen.

If the calibration is successful, the Span Passed screen will be displayed.

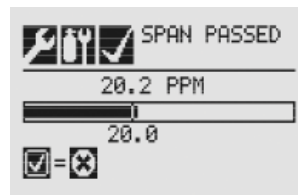

8. Exit the Calibration Menu. After the zero and span calibrations have been successfully completed, the user will be prompted to:

- Exit and turn alarm and fault inhibit off,
- Exit and leave the transmitter in inhibit mode. or
- Not exit



WARNING

When the XNX transmitter is placed in Inhibit Mode, alarms are silenced. This will prevent an actual gas event from being reported. Inhibit Mode must be limited to testing and maintenance only. Exit Inhibit Mode after testing or maintenance activities.

Searchpoint Optima Plus with SHC-1 Handheld Interrogator

Equipment Required:

- Gassing Cover
 - Instrument Air (if a zero in ambient air cannot be guaranteed)
 - Calibration Span Gas (i.e. 2.5% V/V methane for 50% LEL output or 2.2% V/V for 50% UEG)
 - SHC-1 Handheld Interrogator
1. Connect SHC1 Handheld Interrogator to Optima via DX100(M) Junction Box via its IS socket

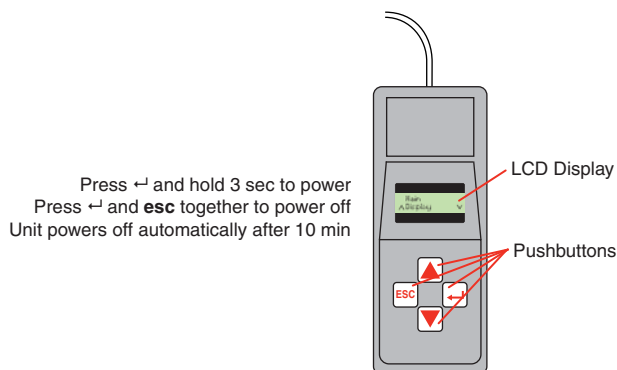
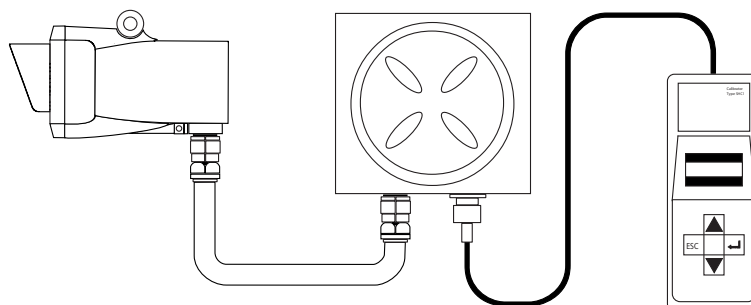

2. Apply power to transmitter and receiver

Functional Response/Bump test:

3. Press and hold ↵ (Enter) key on Interrogator keypad for two seconds to switch unit on
4. Interrogator displays start-up message for approximately three seconds:

```
Z - SHC1 EXCEL
Interrogator 4U0
```

5. Check type of connected detector shown on top line of message. Display shows Excel or Optima+ or

Optima. If the display shows Excel or Optima press ESC

ESC must be pressed within 3 seconds to take effect, toggles Interrogator mode between Excel, Optima Plus and Optima.

6. Start-up message is updated and displayed again for 3 sec

```
Z - SHC1 EXCEL
Interrogator 4U0
```

7. Unit displays Main menu, top level of menu style interface, as follows:

```
Main
^ Display      v
```

First line of display shows current level in menu tree, second line displays sub-menu title, action or data.

8. Select DISPLAY mode on Handheld Interrogator and check displayed gas reading is 0.0% LEL.

```
Optima+ Methane
0.0 %LEL \
```

If displayed gas reading is not 0.0% LEL, check that there is no background gas concentration present, optics are clean and free from condensation and unit has been given sufficient time to stabilize in its operating environment.

For best results, it is recommended that a unit is left powered up for one hour before performing zero or span calibration / test activities

9. Perform a functional gas test – bump test

```
Calibrate
^ Display      v
```

```
Inhibiting 4-20
Please Wait ...
```

```
Optima+ Methane
0.0 %LEL \
```

Detector inhibits 4-20mA output which prevents gas readings from being signaled on 4-20mA output. For a nominal 50% LEL test gas concentration, displayed reading should be between 45% LEL and 55% LEL. If necessary, test gas concentrations between 20%LEL and 95%LEL can be used with same +/- 5% LEL test tolerance

If displayed gas reading falls within +/-5% LEL test tolerance range, functional gas test is successful

10. When concentration levels are below alarm thresholds or at zero, press ESC to return 4-20 output to normal state and exit

Calibration:

11. If not already connected, connect SHC-1, press to power on. Check that the SHC-1 is in Optima+ mode.

```
Z - SHC1 EXCEL
Interrogator 4U0
```

After five seconds the display shows

```
Main
^ Display      v
```

12. Press to move through the menu to the Calibrate Menu; display shows

```

Main
^ Calibrate      v
    
```

13. Press  on the handheld; display shows

```

Calibrate
^ Display      v
    
```

14. Press  to enter the calibration process, display shows

```

Calibrate
^ Cal Sensor   v
    
```

15. Press ; display shows

```

Inhibiting 4-20
Please Wait ...
    
```

Sets analog output to inhibit level (default 2mA) for duration of calibration sequence.

16. Remove weather protection and dust barrier. Check optics are clean and dry - clean/dry optics if necessary then refit dust barrier and weather protection

17. Wait until display shows

```

Ensure Zero Gas
Then Press Enter
    
```

If zero reading in ambient air cannot be guaranteed, fit gassing cover over weather protection and apply instrument air at one liter/minute for 30 sec.

18. Press  to begin Zero Cal; display then shows

```

Processing Data
Please Wait ...
    
```

19. After 10 sec display shows; Zero is now set.

```

Zero Calibrated
    
```

20. Once Zero Cal is complete, after a few seconds, display shows

```

Cal Span, Enter
Exit Cal, Esc
    
```

To continue to Span Calibration, press , to end calibration sequence *without* span calibrating, press ESC.

21. To begin Span Cal, press ; display shows

```

Press Enter to
Select Gas Conc
    
```

22. Set gas concentration, press ; display shows

```
Span Gas
^ 50 % LEL  v
```

Specify gas concentration value. Defaults are 50% LEL: for 2.5% methane or 50% UEG: for 2.2% methane. Use ▲▼ to change displayed gas value in 1% steps to gas concentration used.

23. Press ↵; display shows

```
Press Enter when
Stable: XXX
```

Fit gassing cover over weather protection of unit then apply span gas at one liter/minute and wait for reading to stabilize approximately 30 sec to 1 min.

24. When gas reading stabilizes, press ↵; display shows

```
Processing Data
Please Wait ...
```

25. If successful, after 10 seconds display shows

```
Span Calibrated
```

26. Wait for process to complete and display shows

```
Remove Gas, Press
Enter: XXX
```

27. Remove gassing cover from weather protection. Ensure reading has returned to 00.0% LEL then press ↵; display shows

```
Press Enter to
Release 4-20
```

Releases analog output from 2mA (inhibit signal) to normal operation (4mA)

28. Press and hold ↵; for 3 sec, display shows

```
4-20 Released
```

Analog output is returned to normal operation

29. After the 4-20 inhibit is released, wait and display returns to Calibrate Menu. Press ESC twice to return to Main Menu.

30. Turn off Handheld Interrogator by pressing ESC and ↵ together.



Series 3000 XPIS

Series 3000 XPIS Calibration Procedure

The following equipment is required:

- Appropriate span gas cylinder
- Flow regulator set to 300-375mL/min
- Tubing
- Magnet
- Calibration gas flow housing

NOTE

A compressed air cylinder (20.9%Vol oxygen) should be used to zero cal if area contains any residual target gas. If no residual gas is present then background air can be used to perform zero.

Zero and Span Calibration



CAUTION

Before initial calibration allow the detector to stabilize for 30 minutes after applying power. When in zeroing and span calibration mode the current output from the detector is inhibited (default 3mA) to avoid false alarms.

It is recommended for most sticky gases the tubing should be PTFE with short pieces of rubber tube to make the final connection due to the inflexibility of PTFE. This minimizes adhesion of the gas to the tube surface and allows for more accurate measurement.

NOTE

It is recommended that the calibration is made where the sensor / transmitter have stabilized with their local environment. It is recommended that calibrations be performed at a stable temperature in which the system is to be used. Re-calibration is recommended if the temperature of local environment has varied by more than +/-15 degrees C from the temperature of calibration.

It is essential that the sensor is tested frequently to be sure the system is operating properly. Typically gas detectors should be tested at least twice per year. However it is recommended that testing is conducted on a more frequent basis after initial start up as sensor operation and performance will vary in different environmental conditions and in the presence of other gases. It is the responsibility of the user to determine an appropriate calibration frequency for the application.

1. If using compressed air, push the calibration gas flow housing onto the bottom of the sensor and apply the gas.
2. To access the calibration mode, hold the end of the magnet over the switch located at the top centre of the detector display for at least 5 seconds and then remove.
3. The display will indicate the first menu mode menu 'SEt CAL'.

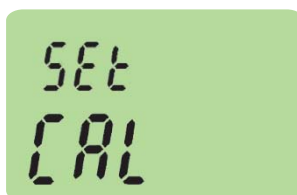

4. Place magnet over the '✓' switch and remove to enter the Calibration menu.
5. The display will show the current gas reading, 'ZEro' and the 'ⓘ' icon flashes.

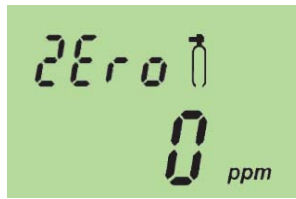

6. When the zero gas reading is stable use '✓' to confirm zero calibration.
7. If successful the display shows 'ZEro PASS' (if not successful, the display shows 'ZEro FAIL' and returns to menu mode).

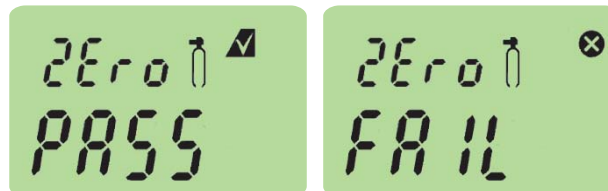

8. If using zero-air, turn it off. Zeroing is complete and saved.
9. The display shows 'SPAN' with 'YES' flashing.



10. If span calibration is required use '✓' proceed to the next step. If span calibration is not required, use '▲▼' to select 'No' and '✓' to return to menu mode.
11. The display shows the current calibration span gas concentration flashing. Use '▲▼' to change the calibration span gas concentration, and '✓' when required span calibration level is set.



12. Span calibration point is displayed with 'YES' flashing. Use '✓' to confirm or '▲▼' to select 'No' and return and enter a new span calibration point.



13. The display will show the current gas reading, 'SPAN' and the gas cylinder icon flashes.



14. Connect the regulator to the span gas cylinder.

15. Apply the span gas to the sensor using the calibration gas flow housing. The live gas reading is displayed. When the reading is stable, use '✓' to confirm span calibration.
16. If the sensor cell has been replaced the following display may be shown.

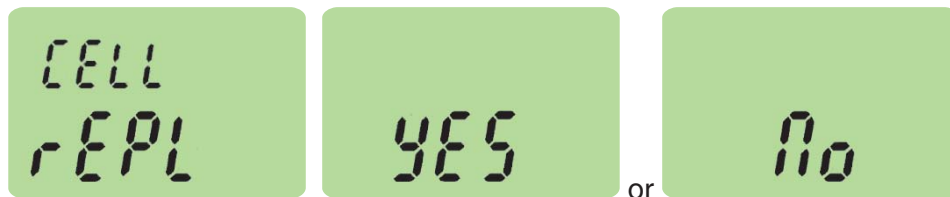

17. Use '▲▼' to select 'YES' if the sensor cell has been replaced or 'No' if it has not been replaced.

⚠ WARNING

Answer Yes to "CELL/rEPL" ONLY in cases where the "Serviceable Sensor Cell Replacement" procedure was been performed. Answering Yes in cases where the cell has not been replaced could result in the inability of the Series 3000 to recognize an old cell with an inadequate output.

It is recommended to bump test the sensors frequently to ensure proper operation.

18. If the sensor cell has been replaced use '✓' to confirm the gas reading.
19. If the span calibration is successful the instrument will briefly display 'SPAN PASS' (if fails 'SPAN FAIL' displayed and returns to menu mode).

NOTE

The calibration due warning counter is reset after a successful calibration.



20. The display alternates between "Pur GAS" and the gas reading to indicate that the unit is expecting the span gas to be removed from the sensor.



21. Promptly switch off the calibration span gas and remove the calibration gas flow housing from the sensor to allow the gas to disperse.
22. When the reading falls below 50% of the calibration gas level the display indicates a countdown (up to 180 seconds dependant on gas type).



23. When the countdown is finished, the calibration procedure is complete.
24. The instrument returns to the 'SEt CAL' menu. Activate the '▲' or '▼' switch to select another menu or

select 'Quit' to return to normal monitoring mode.



Zero and Span Calibration of Hydrogen Sulfide sensors

Hydrogen Sulfide sensors can be affected by extreme humidity changes. A sudden increase in ambient humidity can result in a short-term positive drift in the instrument's reading. A sudden decrease in ambient humidity can result in a short-term negative drift in the instrument's reading. These are most likely to be noticed during calibration with dry or cylinder gas.

When calibrating Hydrogen Sulfide cartridges the following should be taken into account while following the calibration procedure:

1. To zero the sensor, use a compressed air cylinder of 20.9%Vol oxygen (not Nitrogen). Do not use background air.
2. Apply the gas to the sensor for three minutes before using '✓' to confirm the zero calibration.
3. If a span calibration is to be performed, the span calibration gas should be applied to the sensor immediately after the zeroing procedure. Do not allow the sensor to return to ambient air conditions between steps 2 and 3.
4. Apply the span gas for two minutes before using '✓' to confirm the span calibration



Sensepoint Toxic

Sensepoint Toxic Calibration Procedure

The Sensepoint toxic sensor is supplied pre-calibrated, however, for increased accuracy in specific applications, on-site system calibration is recommended.

 **CAUTION**

Re-calibration should only be attempted by qualified service personnel.

Calibration should only be attempted after the sensor has been installed and power applied for a time exceeding the stabilization time. In the first instance the initial calibration should be performed at the control card for the sensor. If there is insufficient span or zero control at the control card, adjustments can be performed using the potentiometers on the sensor.

1. Ensure that power is applied to the sensor and the sensor output is stable.
2. First ensure there is no target gas present, and zero the sensor at the control card. If the target or a cross interfering gas is suspected to be in the vicinity of Sensepoint, it may be necessary to connect a cylinder of zero gas to a Flow Housing and pass clean air across the sensor at 1 litre per minute to allow for a stable zero to be achieved.

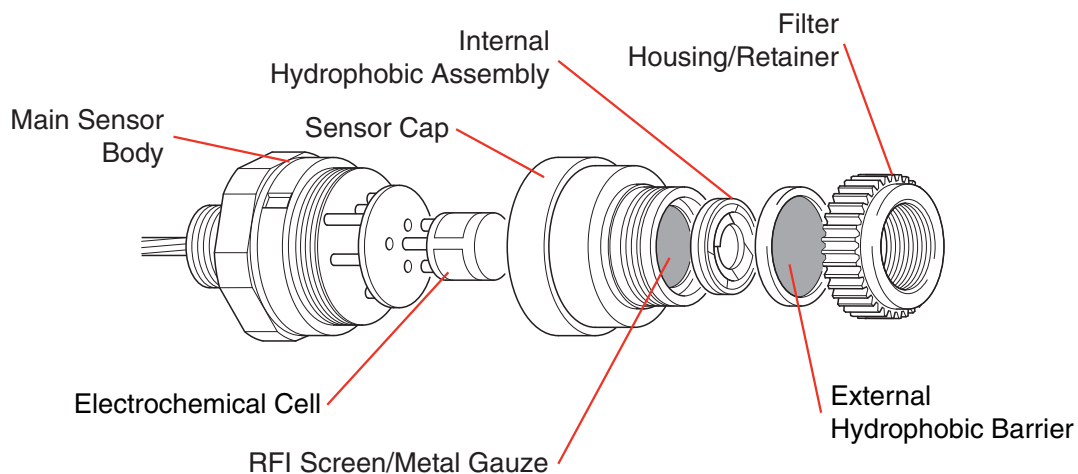

3. To set the sensor span, fit the Flow Housing and connect a gas cylinder of known concentration (approximately 50% FSD in air) to the Flow Housing accessory using nylon or PTFE tubing.

Tubing lengths should be kept to a minimum to avoid reducing speed of response.

NOTE:

When calibrating for Nitrogen Oxide, and because Nitrogen Oxide is unstable when mixed with Oxygen, a mixture of Nitrogen Oxide in Nitrogen is used. The applied gas flow time should be kept to the minimum needed to obtain the necessary readings.

 **CAUTION**

The test gas may be hazardous, it is important that the outlet of the Flow Housing is exhausted to a safe area.

4. Apply the gas at a flow rate of 1 liter per minute for the recommended application time (see Test Gas Concentrations table below).

The flow rate for calibration in fast air flows must be adjusted as follows:

Wind Speed (mph)	Measured Speed Using Pitot (m/s)	Test Gas Flow Rate (L/min) Series 2000
0	0.0	1.0
5	2.2	1.0

Wind Speed (mph)	Measured Speed Using Pitot (m/s)	Test Gas Flow Rate (L/min) Series 2000
10	4.4	1.5
15	6.7	1.5
20	8.9	1.5
25	11.1	1.5
30	13.4	1.5
35	15.6	1.5
40	17.8	1.5

- Adjust the span at the control card to read the concentration of the gas applied.
- Remove the Flow Housing and gas supply.

Test Gas Concentrations

Gas	Range	Recommended Test Concentration	Application Time	Operating Temp.	
				Min.	Max.
H ₂ S	0 to 20ppm	10ppm	3 min	-20°C	+50°C
H ₂ S	0 to 50ppm	20ppm	3 min	-20°C	+50°C
H ₂ S	0 to 100ppm	50ppm	3 min	-20°C	+50°C
CO	0 to 100ppm	50ppm	3 min	-20°C	+50°C
CO	0 to 200ppm	100ppm	3 min	-20°C	+50°C
CO	0 to 500ppm	250ppm	3 min	-20°C	+50°C
Cl ₂	0 to 5ppm	3ppm	10 min	-20°C	+50°C
Cl ₂	0 to 15ppm	10ppm	10 min	-20°C	+50°C
O ₂	0 to 25% V/V	19% V/V	1 min	-15°C	+40°C
NH ₃	0 to 50ppm	25ppm	10 min	-20°C	+40°C
NH ₃	0 to 1000ppm	500ppm	10 min	-20°C	+40°C
H ₂	0 to 1000ppm	500ppm	3 min	-5°C	+40°C
H ₂	0 to 10000ppm	3000ppm	3 min	-5°C	+40°C
SO ₂	0 to 15ppm	10ppm	5 min	-15°C	+40°C
SO ₂	0 to 50ppm	20ppm	5 min	-15°C	+40°C
NO	0 to 100ppm	50ppm	5 min	-5°C	+40°C
NO ₂	0 to 10ppm	5ppm	5 min	-15°C	+40°C
NO ₂	0 to 50ppm	20ppm	5 min	-15°C	+40°C

If it is necessary to adjust the sensor set up because insufficient span or zero adjustment is available at the control card, follow these instructions:

- Open the sensor enclosure by unscrewing the sensor cap assembly from the sensor main body and replace with a Gassing Cap (P/N: 2106D2114) and Flow Housing (P/N: 02000-A-1645).
- If the output, with no gas applied, is not zero then adjust the zero potentiometer through the Gassing Cap access holes (see following diagram) to obtain a zero indication.
- Connect a gas cylinder of known gas concentration of approximately 50% FSD to the Flow Housing using nylon or PTFE tubing.

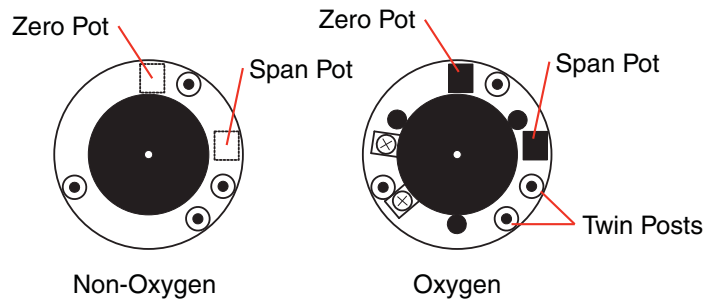

CAUTION

The test gas may be hazardous, it is important that the outlet of the Flow Housing is exhausted to a safe area.

4. Apply gas at a flow rate of 1 litre per minute for the recommended application time.
5. Adjust the span pot through the Gassing Cap access holes to read the concentration of gas applied.
6. Remove the Gassing Cap and Flow Housing and replace with the original sensor cap fitted with a new hydrophobic assembly.

NOTE:

Some gases, such as Chlorine, H₂S and Ammonia can stick to the walls of tubes, regulators and sensors. It is advisable that, when calibrating with these gases, the pipes used are as short as possible and that the sensor reaches a maximum value before spans are adjusted.



SQN8x

SQN8x Calibration Procedure

Zero Calibration - Option 1 Configuration

1. Connect 1LPM regulator to a Zero Air grade gas cylinder
2. Attach a “tee” to the regulator
3. Attach a freon filter to the tee
4. Connect open port of the tee to the SQN8x inlet port
5. Be sure the SQN8x is in “Zero Calibration” mode for the desired channel.

The sample pump will draw the required zero gas from the cylinder. Any excess flow will be routed to the Freon filter.



CAUTION

NEVER force a sample into the SQN8x, damage to the unit may result

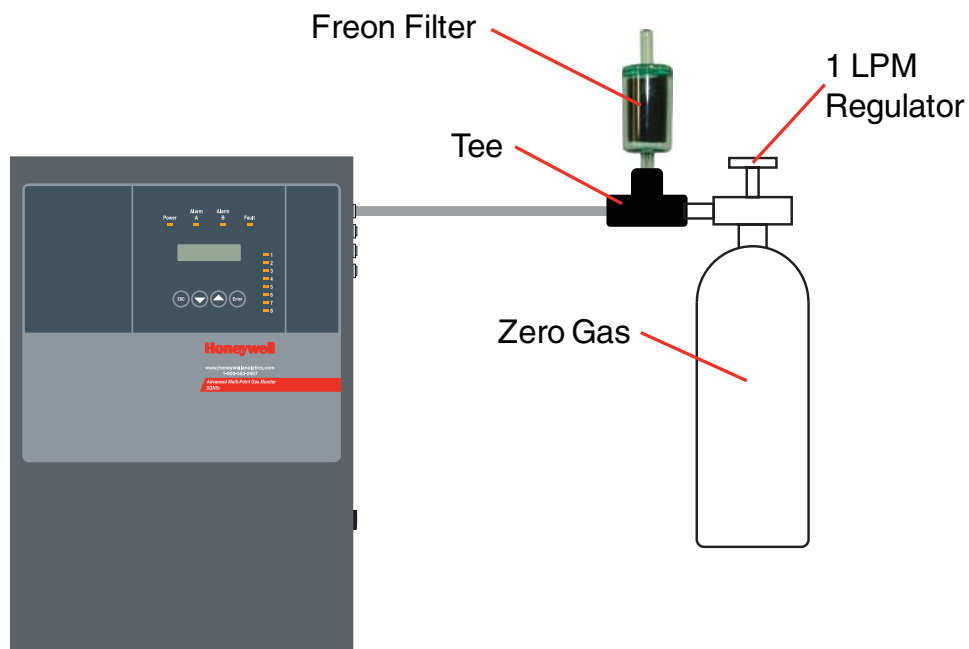

Zero Calibration - Option 2 Configuration

1. Connect demand flow regulator to Zero Air grade gas cylinder
2. Be sure the SQN8x is in “Zero Calibration” mode for the desired channel

The sample pump will draw the required zero gas from the cylinder.

CAUTION

NEVER force a sample into the SQN8x, damage to the unit may result

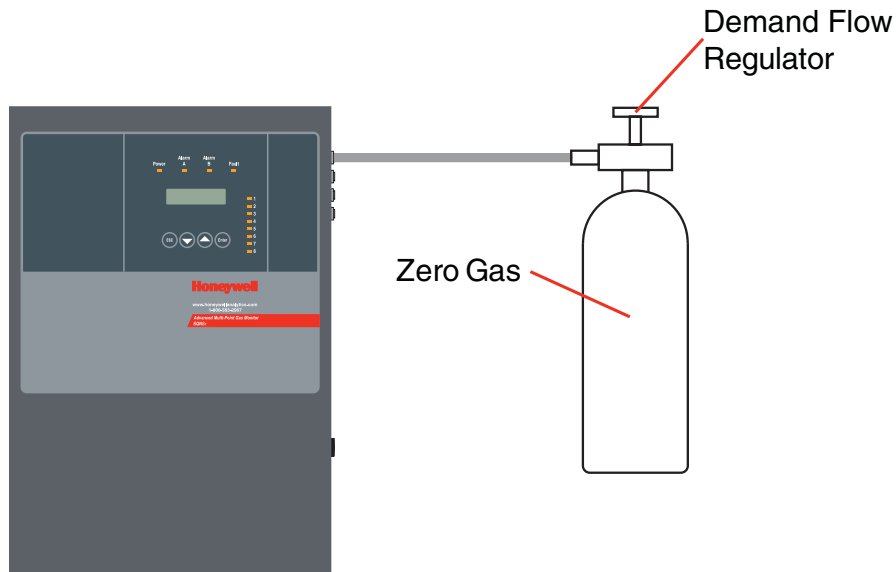

Regardless of gassing configuration, the SQN8x must be in “Calib Zero” mode to zero the unit.

NOTE:

Perform a Zero Calibration before attempting a Span Calibration. Ensure the background is free of potential gases or apply zero grade air

1. Navigate to Programming > Calib Zero.

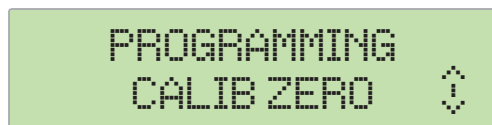

2. Select the sensor to be zeroed.



3. ENTER to begin sensor zero.

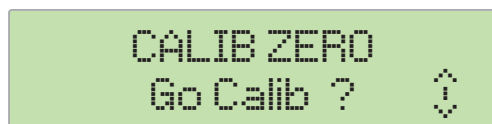

4. Display returns to CALIB ZERO when complete.



Span Calibration - Option 1 Configuration

1. Connect 1LPM regulator to a Span gas cylinder
2. Attach a “tee” to the regulator
3. Attach a freon filter to the tee
4. Connect open port of the tee to the SQN8x inlet port
5. Be sure the SQN8x is in “Span Calibration” mode for the desired channel.

The sample pump will draw the required span gas from the cylinder. Any excess flow will be routed to the Freon filter and captured.



CAUTION

NEVER force a sample into the SQN8x, damage to the unit may result

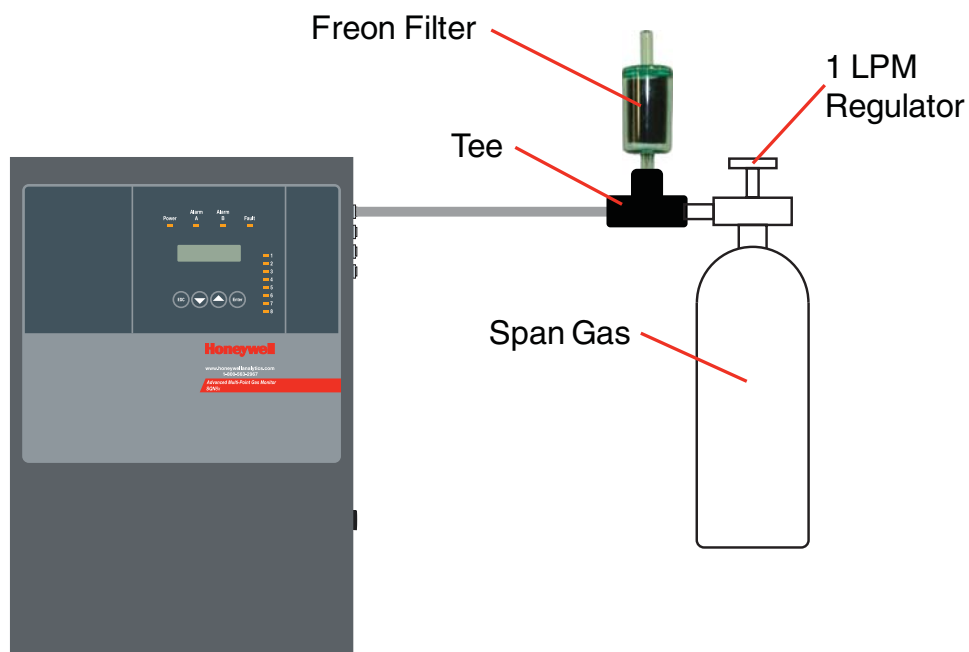

Span Calibration - Option 2 Configuration

1. Connect demand flow regulator to Span gas cylinder
2. Be sure the SQN8x is in "Span Calibration" mode for the desired channel

The sample pump will draw the required span gas from the cylinder.



CAUTION

NEVER force a sample into the SQN8x, damage to the unit may result

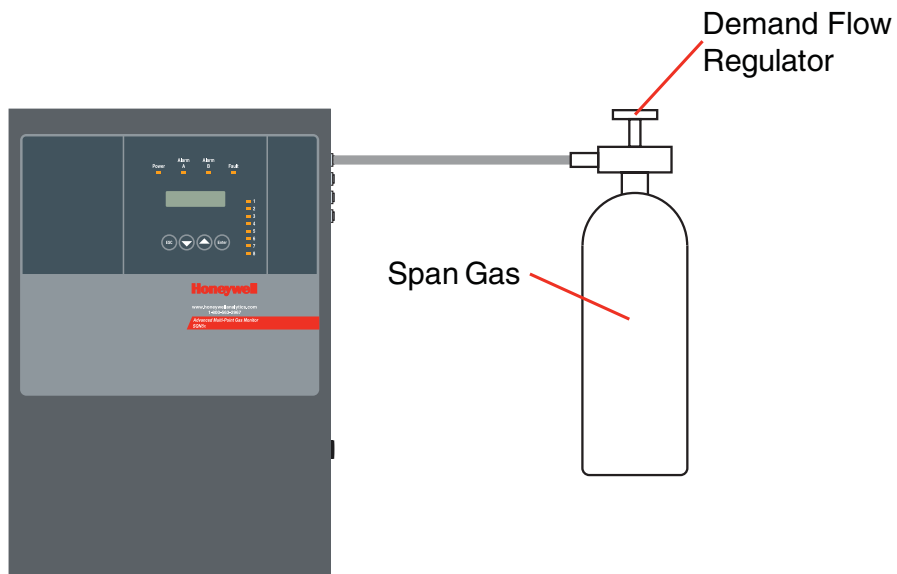

Span Calibration - Option 3 Configuration

1. Fill a gas bag with target sample gas

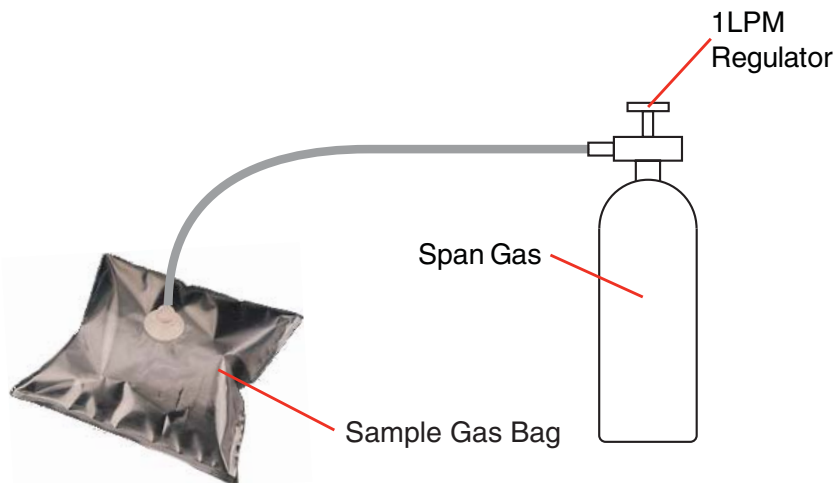

2. Enter "Calibration" menu of SQN8x for the desired channel
3. Attach the tubing to the desired inlet point of the SQN8x
4. Attach SQN8x to gas bag port.

The sample pump will draw the sample gas from the gas bag

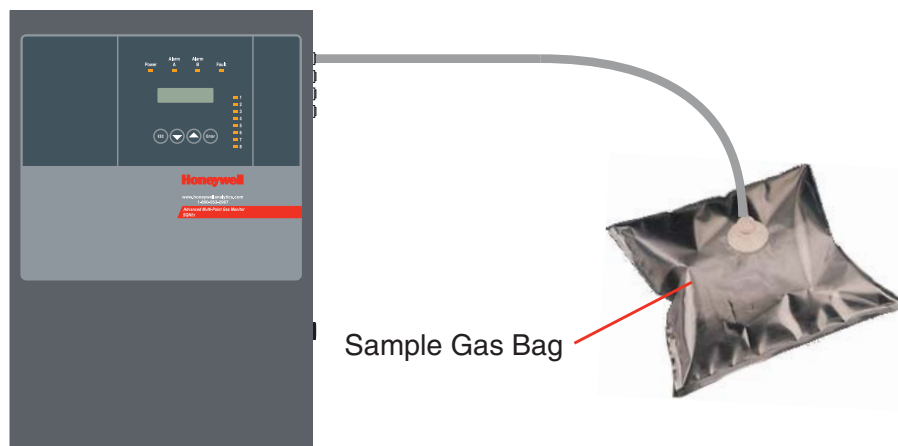

Regardless of gassing configuration, the SQN8x must be in "Calib Span" mode to span the unit.

NOTE:

Perform a Zero Calibration before attempting a Span Calibration. Ensure the background is free of potential gases or apply zero grade air

1. Navigate to Programming > Calib Span.

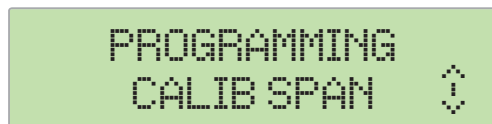

2. Select the sensor to be zeroed.



3. ENTER to begin sensor zero.

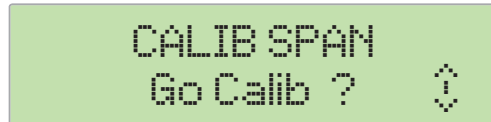

CALIB SPAN
Go Calib ? ⏏

4. Display returns to CALIB SPAN when complete.



CALIB SPAN
0% ⏏



Sensepoint XCD

Sensepoint XCD Calibration

It is recommended to periodically carry out a gas response check on the Sensepoint XCD to ensure correct operation. This may be done in two ways;

1. A simple Response Check often referred to as a “BUMP TEST” is a test using calibration gas applied to the sensor via the nozzle of the Weather Protection or using the Sensepoint XCD Gassing Cap.
If a BUMP TEST is done via the Weather Protection nozzle it may be necessary in windy conditions to increase the flow rate of the test gas by a further 1 LPM, OR, to shelter the weather protection from the wind.
2. A full gas calibration of the sensor as described in the following section, using ONLY the Sensepoint XCD Gassing Cap (Part No.: S3KCAL).

Zero and Span



CAUTION

Before initial calibration allow the detector to stabilize for 30 minutes after applying power.

When in zeroing and span calibration mode the current output from the detector is inhibited (default 2mA) to avoid false alarms.

For Flammable gas calibration use a calibration gas concentration of between 25%LEL and 75%LEL to ensure that the required accuracy can be attained.

For Hydrogen Sulfide type sensors refer to section 10.1.2 before conducting zero and span calibration.

To calibrate the detector, use an appropriate span gas cylinder, constant flow regulator AND the Sensepoint XCD Gassing Cap. The flow rates used for calibration gas are as follows:

Gas Type	Flow rate (L / Min)
Air or N2 for Zero	0.5 to 1.0
Flammable CAT	1 to 1.5
O2	0.5 to 1.0
H2S	0.5 to 1.0
CO	0.5 to 1.0
H2	0.5 to 1.0
NO2	0.5 to 1.0
Flammable IR	0.4 to 0.6
CO2 IR	0.4 to 0.6

A compressed air cylinder (20.9%Vol oxygen) should be used to perform the zero calibration if the area where the detector is located contains any residual amount of the target gas. If no residual gas is present then the background air can be used to perform the zero calibration. Contact your Honeywell Analytics representative for details of suitable calibration kits.

To calibrate the detector follow the procedure below.

NOTE

Oxygen sensor does not require a zeroing procedure. Background air (20.9%Vol oxygen) can be used to span the oxygen sensor in place of a compressed air cylinder (20.9%Vol oxygen). For oxygen sensors only do parts 1-4, 12, 13 (if compressed air cylinder is used), 14-17 and 22 of the procedure below.

Zero Calibration

1. If the ambient air is NOT considered reliable to use to set the ZERO, then remove the weather protection and fit the Gassing Cap accessory onto the sensor and apply a clean source of zero gas or compressed air.
2. To access the calibration menu, hold the end of the magnet over the switch located at the top center of the detector display (✓) for at least 3 seconds and then remove.
3. The display will indicate the first configuration mode menu 'SEt CAL'.



4. Put the magnet over the '✓' switch again and move to enter the Calibration menu.
5. The display will show the current gas reading, and the '0' icon flashes.



6. When the zero gas reading is stable use '✓' to confirm zero calibration.
7. If successful the display shows 'ZEro PASS' (if not successful, the display shows 'ZEro FAIL' and returns to configuration mode).



8. If using zero-air, turn it off. Zeroing is complete and saved.
9. The display shows 'SPAN' with 'YES' flashing.

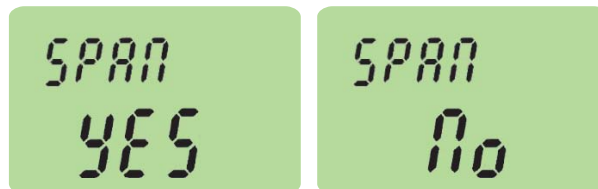

10. If span calibration is required use '✓' proceed to the next step. If span calibration is not required, use '▼▲' to select 'No' and '✓' to return to configuration mode.

Span Calibration

11. The display shows the current calibration span gas concentration while flashing the ' ' icon. Use '▼▲' to change the calibration span gas concentration, and '✓' when required span calibration level is set.



12. The display will show the current gas reading, and the ' ' icon flashes.
 13. Connect the regulator to the span gas cylinder.
 14. Apply the span gas to the sensor using the Sensepoint XCD Gassing Cap. The live gas reading is displayed. When the reading is stable, use '✓' to confirm span calibration.



15. If the sensor has been replaced the following display may be shown.



16. Use '▼▲' to select 'YES' if the sensor has been replaced or 'No' if it has not been replaced.
 17. If the span calibration is successful the instrument will briefly display 'SPAN PASS' (if fails 'SPAN FAIL' displayed and returns to configuration mode).

NOTE

Calibration due warning counter is reset after a successful calibration.



18. The display alternates between "Purg gAS" and the gas reading to indicate that the unit is expecting the span gas to be removed from the sensor.

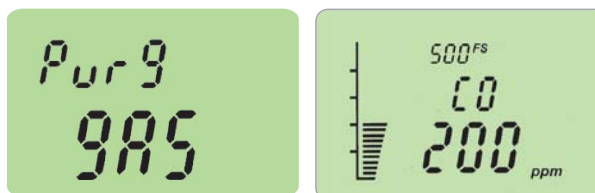

19. Promptly switch off the calibration span gas and remove the Sensepoint XCD Gassing Cap from the sensor to allow the gas to disperse.

20. When the reading falls below 50% of the calibration gas level the display indicates a countdown (up to 180 seconds dependant on gas type).



21. When the countdown is finished, the calibration procedure is complete.

22. The instrument returns to the 'Set CAL' menu. Activate the '▼' or '▲' switch to select another menu or select 'Quit' to return to normal monitoring mode.



NOTE

Remember to always replace the Weather Protection and other accessories.

Zero and Span Calibration of Hydrogen Sulfide sensors

Hydrogen Sulfide sensors can be affected by extreme humidity changes. A sudden increase in ambient humidity can result in a short-term positive drift in the instrument's reading. A sudden decrease in ambient humidity can result in a short-term negative drift in the instrument's reading. These are most likely to be noticed during calibration with dry or cylinder gas.

When calibrating Hydrogen Sulfide cartridges the following should be taken into account while following the Span/Zero procedure:

1. To zero the sensor, use a compressed air cylinder of 20.9%Vol oxygen (not Nitrogen). Do not use background air.
2. Apply the gas to the sensor for three minutes before using '✓' to confirm the zero calibration.
3. If a span calibration is to be performed, the span calibration gas should be applied to the sensor immediately after the zeroing procedure. Do not allow the sensor to return to ambient air conditions between steps 2 and 3.
4. Apply the span gas for two minutes before using '✓' to confirm the span calibration.



Sensepoint XCD-RTD

Sensepoint XCD-RTD Calibration Procedure

It is recommended to periodically carry out a gas response check on the Sensepoint XCD RTD to ensure correct operation. This may be done in two ways;

1. A simple Response Check often referred to as a “BUMP TEST” is a test using calibration gas applied to the sensor via the Weather Protection or using the Sensepoint Gassing Cap.

If a BUMP TEST is done via the Weather Protection it may be necessary in windy conditions to increase the flow rate of the test gas by a further 1 LPM, OR, to shelter the weather protection from the wind.

2. A full gas calibration of the sensor as described in the following section, using ONLY the Gassing Cap



Gassing Cap Kit 2106D2114

Zero and Span Calibration



Before initial calibration allow the detector to stabilize for 30 minutes after applying power.

When in zeroing and span calibration mode the current output from the detector is inhibited (default 2mA) to avoid false alarms.

To calibrate the detector, use an appropriate span gas cylinder, constant flow regulator and the Sensepoint Toxic Gassing Cap (refer to Sensepoint Technical Manual for details). The flow rate is used of approximately 1 to 1.5 litres per minute for calibration.

Apply the gas at the flow rate for the recommended application concentration and time please see table below.

Test Gas Concentrations

Gas	Range	Recommended Test Concentration	Application Time	Operating Temp.	
				Min.	Max.
H2S	0 to 20ppm	10ppm	3 min	-20°C	+50°C
H2S	0 to 50ppm	20ppm	3 min	-20°C	+50°C
H2S	0 to 100ppm	50ppm	3 min	-20°C	+50°C
CO	0 to 100ppm	50ppm	3 min	-20°C	+50°C
CO	0 to 200ppm	100ppm	3 min	-20°C	+50°C
CO	0 to 500ppm	250ppm	3 min	-20°C	+50°C
Cl2	0 to 5ppm	3ppm	10 min	-20°C	+50°C
Cl2	0 to 15ppm	10ppm	10 min	-20°C	+50°C
O2	0 to 25% V/V	19% V/V	1 min	-15°C	+40°C
NH3	0 to 50ppm	25ppm	10 min	-20°C	+40°C
NH3	0 to 1000ppm	500ppm	10 min	-20°C	+40°C
H2	0 to 1000ppm	500ppm	3 min	-5°C	+40°C
H2	0 to 10000ppm	3000ppm	3 min	-5°C	+40°C
SO2	0 to 15ppm	10ppm	5 min	-15°C	+40°C
SO2	0 to 50ppm	20ppm	5 min	-15°C	+40°C
NO	0 to 100ppm	50ppm	5 min	-5°C	+40°C
NO2	0 to 10ppm	5ppm	5 min	-15°C	+40°C
NO2	0 to 50ppm	20ppm	5 min	-15°C	+40°C

A compressed air cylinder (20.9%Vol oxygen) should be used to perform the zero calibration if the area where the detector is located contains any residual amount of the target gas. If no residual gas is present then the background air can be used to perform the zero calibration. Contact your Honeywell Analytics representative for details of suitable calibration kits.

To calibrate the detector follow the procedure below.

NOTE:

The Oxygen sensor does not require a zeroing procedure. Background air (20.9%Vol oxygen) can be used to span the oxygen sensor in place of a compressed air cylinder (20.9%Vol oxygen). For oxygen sensors only do parts 1-4, 13, 14 (if compressed air cylinder is used), 15-17 and 22 of the procedure below.

Zero Calibration

1. If the ambient air is NOT considered reliable to use to set the ZERO, then remove the weather protection and fit the Gassing Cap accessory onto the sensor and apply a clean source of zero gas or compressed air.
2. To access the calibration menu, hold the end of the magnet over the switch located at the top center of the detector display (✓) for at least 3 seconds and then remove.
3. The display will indicate the first configuration mode menu 'SEt CAL'.

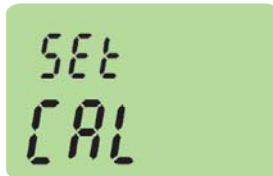

4. Put the magnet over the '✓' switch again and move to enter the Calibration menu.
5. The display will show the current gas reading, and the  icon flashes.



6. Observe the Zero reading on the XCD RTD display. If it shows a stable reading of zero gas "0" there is no need to carry out any further adjustment. If not, it is necessary to adjust the sensor set up follow the next step.
7. Open the sensor enclosure by unscrewing the sensor cap assembly from the sensor main body and replace with a Gassing Cap (P/N: 2106D2114) and Flow Housing (P/N: 02000-A-1645).

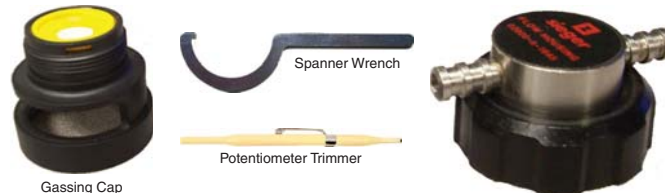

Gassing Cap Kit 2106D2114 and Flow Housing 02000-A-1645

If the output, with no gas applied, is not zero then adjust the zero potentiometer through the Gassing Cap access holes to obtain a zero indication.

Connect the regulator to the span gas cylinder. Apply gas at a flow rate of 1 litre per minute for the recommended application time.

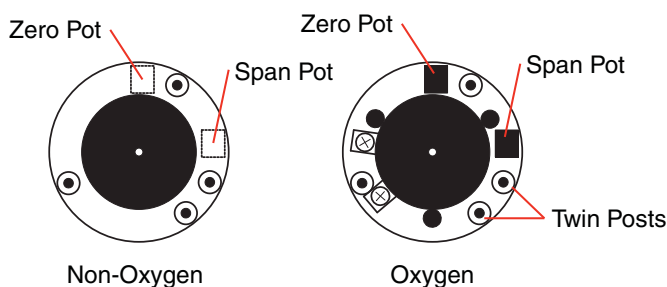

Sensepoint Toxic Sensor Zero and Span potentiometer

NOTE:

Span potentiometer located closest to the twin posts.

Please refer to Sensepoint Technical Manual or the detail procedure on how to adjust the Zero and Span potentiometer.

- When the zero gas reading is stable use '✓' to confirm zero calibration.



- If using zero-air, turn it off. Zeroing is complete and saved.
- The display shows 'SPAN' with 'YES' flashing.
- If span calibration is required use '✓' proceed to the next step. If span calibration is not required, use '▼▲' to select 'No' and '✓' to return to configuration mode.

Span Calibration

- The display shows the current calibration span gas concentration while flashing the ' ' icon. Use '▼▲' to change the calibration span gas concentration, and '✓' when required span calibration level is set.



- The display will show the current gas reading, and the ' ' icon flashes.



NOTE:

This example assumes a 250ppm span gas for a 0-500ppm CO range for the whole procedure of the calibration.

- Connect the regulator to the span gas cylinder. Apply gas at a flow rate of 1 litre per minute for the recommended application time.
- Apply the span gas to the sensor using the Sensepoint Gassing Cap. The live gas reading is displayed. Observe the Span reading on the XCD RTD display. If it shows a stable reading of span gas "250" there is no need to carry out any further adjustment. If not, it is necessary to adjust the sensor set up follow

the next step.

- If the output, with span gas applied, is not the concentration of span gas then adjust the span potentiometer through the Gassing Cap access Holes to obtain a span gas concentration indication.

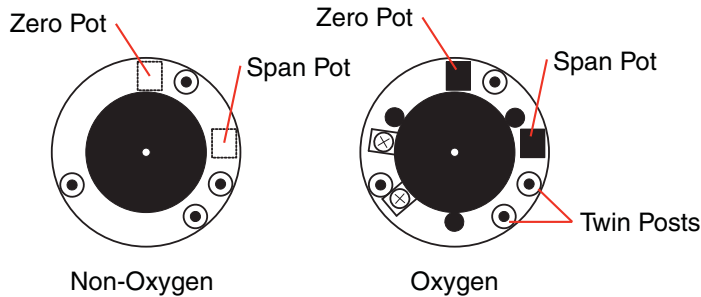

- When the reading is stable, use '✓' to confirm span calibration.



- The display alternates between "Purg gAS" and the gas reading to indicate that the unit is expecting the span gas to be removed from the sensor.

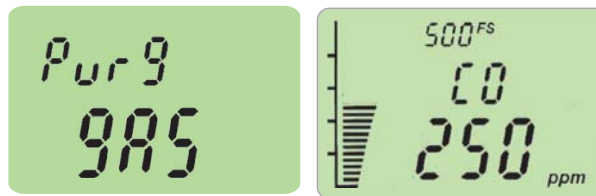

- Promptly switch off the calibration span gas and remove the Sensepoint Gassing Cap from the sensor to allow the gas to disperse.
- When the reading falls below 50% of the calibration gas level the display indicates a countdown (up to 180 seconds dependant on gas type).



- When the countdown is finished, the calibration procedure is complete.
- The instrument returns to the 'Set CAL' menu. Activate the '▲' or '▼' switch to select another menu or select 'Quit' to return to normal monitoring mode.

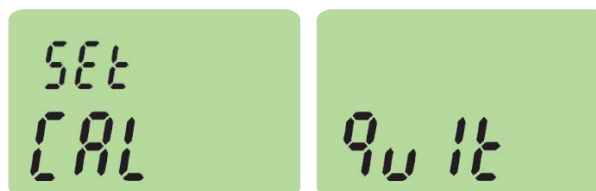

- Remove Gassing Cap and reinstall sensor cap assembly removed in step 7.

NOTE:

Remember to always replace the Weather Protection and other accessories.



XNX Universal Transmitter

XNX Calibration Procedure

Each of the sensor technologies supported by the XNX® Universal Transmitter uses unique calibration procedures. The description provided illustrates the XNX interface with the sensor. The description does not replace the procedures found in each sensor’s operating manual.

The Gas Calibration menu is used for Zero and Span calibration as well as functional gas testing (bump test). The Gas Calibration menu is accessed from the Main Menu.

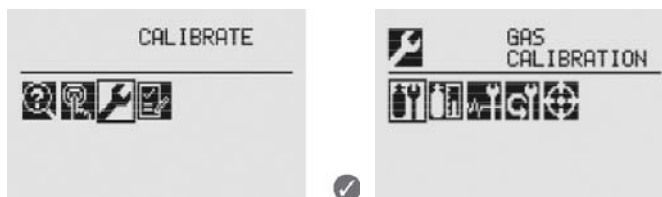

This table shows the Gas Calibration menu icons:

Symbol	Description
	Gas Calibration
	Bump Test
	Calibrate mA Output
	Soft Reset
	Align Excel

WARNING

Do not use the XNX Universal Transmitter in oxygen-enriched atmospheres. Concentrations displayed will be adversely affected by oxygen depletion.

CAUTION

The calibration procedure should be performed only by qualified personnel. Take appropriate precautions with cylinders of flammable and toxic gases.

The default calibration values for the “Calibration Required” diagnostic vary based on sensor type. This value can be reprogrammed in accordance with site requirements to ensure the highest level of safety. Correct operation of each sensor should be confirmed before each use by calibration with a certified test gas of known concentration before commissioning

CAUTION

Recalibrate if the temperature of local environment has varied by more than $\pm 15^{\circ}\text{C}$ from the temperature of calibration.

WARNING

Honeywell recommends periodic bump tests (every 30 days or in accordance with customer site procedures) to the sensor to insure proper operation and compliance with the functional safety rating of the installation.

Zero and Span Calibration for XNX

CAUTION

Before initial calibration, allow the sensor to stabilize for 30 minutes after applying power. When in Zero and Span Calibration modes, the current output from the sensor is inhibited (default 2mA) to avoid false alarms.

For most sticky gases (e.g., HCl, Cl₂) use PTFE tubing with short pieces of rubber tube for the final connection (due to the inflexibility of PTFE). This minimizes adhesion of the gas to the tube surface and allows more accurate measurement.

To calibrate the sensor, use an appropriate span gas cylinder, tubing, magnet, and calibration gas flow housing. Set the flow regulator to 300-375 ml/min for XNX EC sensors or 500 ±200 ml/min for XNX mV sensors. A compressed gas cylinder (20.9%Vol oxygen) should be used to perform the zero calibration if the area where the sensor is located contains any residual amount of the target gas. If no residual gas is present, background air can be used to perform the zero calibration. Contact a Honeywell Analytics representative for details about suitable calibration kits.

NOTE

The oxygen sensor does not require a zeroing procedure. Background air (20.9%Vol oxygen) can be used to span the oxygen sensor in place of a compressed air cylinder (20.9%Vol oxygen).

EN performance standards require 10 minutes stabilization time for application of zero and span gas for performance-approved EC, mV, and IR sensors prior to calibration.

Zero Calibration

This section outlines the steps for calibrating the transmitter's attached sensors.

NOTE

The Zero Calibration procedure should be performed prior to the Span Calibration procedure.

1. If using a compressed gas cylinder, push the calibration gas flow housing onto the bottom of the sensor and apply the gas.
2. Access the Gas Calibration Menu.

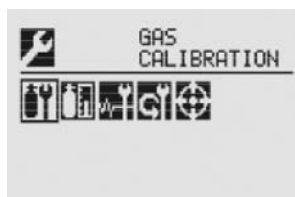



NOTE

The Gas Calibration menu is for both Zero Calibration and Span Calibration.

Zero Calibration



As the sensor detects the gas and the concentration increases, the values displayed will reflect the changing concentration. When the concentration values are stable, 3 minutes, select  to allow the transmitter to calculate the zero adjustment. Selecting  will return to the Gas Calibration menu.



If the zero calibration is successful, the transmitter will display the Zero Passed screen.

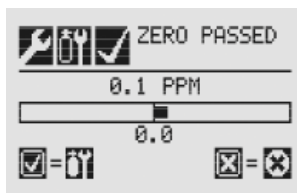

Span Calibration

If a Span Calibration is not required, select the to skip the Span Calibration and return to the Calibration menu.

- When the Zero Calibration is complete, the Span Concentration screen appears. The gas concentration for the Span Gas Calibration can be changed. If the Span Calibration is skipped, the Gas Calibration screen displays.

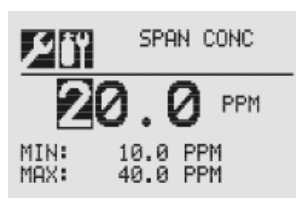

- Enter the concentration of the span gas by selecting to choose the first digit. Use the switches to increment or decrement the values. Use to accept the new value and move to the next digit. Continue until all digits have been selected.

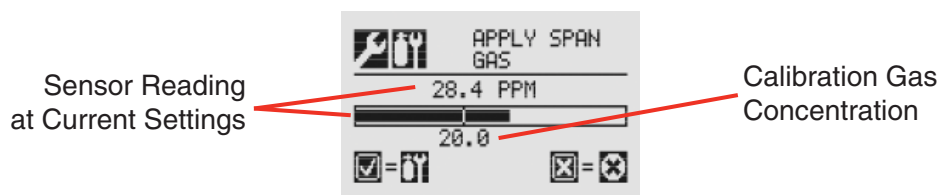

- Apply the span gas. Pass the gas through the flow housing at a rate of 300-375 ml/min for XNX EC sensors. As the sensor detects the gas and the concentration increases, the values displayed will reflect the changing concentration. When the concentration values are stable, select to perform the span. The Span Calibration process also determines whether the sensor is within the proper range to accurately detect the target gas.

Selecting will cancel the span calibration and return to the Gas Calibration menu.

- When the sensor has completed the calibration and the span algorithms have determined that it is within range, the Span Passed screen will appear.

If the calibration is not successful, the Span Failed screen will display. Selecting will return to the Span Concentration screen to begin the span calibration again. Selecting will exit Span Calibration and return to the Gas Calibration Menu.

Once the Zero Gas and Span calibrations are completed successfully, the user will be prompted to:

- exit with inhibit off
- exit with inhibit on, or
- not exit.

WARNING

When the XNX transmitter is placed in Inhibit Mode, alarms are silenced. This will prevent an actual gas event from being reported. Inhibit Mode must be limited to testing and maintenance only. Exit Inhibit Mode after testing or maintenance activities.

Using the Calibration Cup

1. Snap the calibration cup into the weather protector. The two protrusions on the cup fit into recesses in the weather protector.
2. Attach the hose from the gas cylinder to the calibration cup. Note that the cup's flow is unidirectional. There is an arrow on the bottom showing flow direction
3. Adjust the calibration flow rate¹.

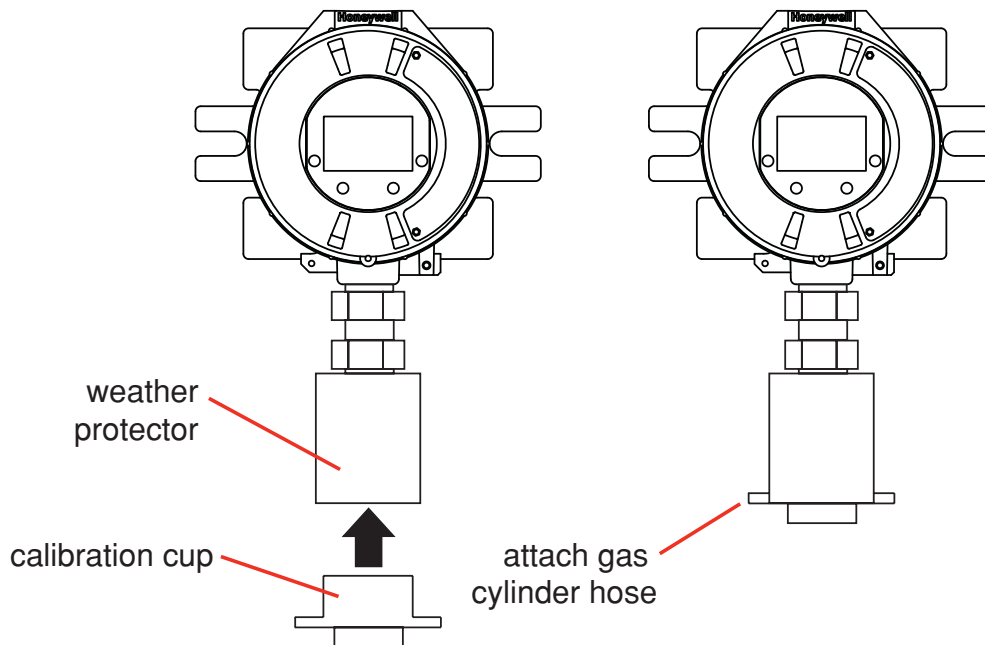

¹ 300-375 ml/min for XNX EC sensors, 500 ±200 ml/min for XNX mV sensors, unless otherwise directed

Zero and Span Calibration of XNX EC Hydrogen Sulfide (H₂S) Sensors

CAUTION

Before initial calibration, allow the sensor to stabilize for 30 minutes after applying power. When in zero and span calibration modes, the current output from the sensor is inhibited (default 2mA) to avoid false alarms.

Recalibrate if the temperature of local environment has varied by more than ±15°C from the temperature of calibration.

Hydrogen Sulfide sensors can be affected by extreme humidity changes. A sudden increase in ambient humidity can result in a short-term positive drift in the instrument's reading. A sudden decrease in ambient humidity can result in a short-term negative drift in the instrument's reading. These are most likely to be noticed during calibration with dry or cylinder gas.

When calibrating hydrogen sulfide cartridges, the following should be taken into account

1. To zero the sensor, use a compressed gas cylinder of 20.9%Vol oxygen (not nitrogen). Do not use background air.

If a span calibration is to be performed, the span calibration gas should be applied to the sensor immediately

after the zeroing procedure. Do not allow the sensor to return to ambient air conditions.

⚠ WARNING

Long-term exposure (> 20 minutes) to concentrations exceeding the full-scale range of the sensor can cause it to lose sensitivity. The output of the sensor may then decrease in value even though high levels of toxic gas are still present. Before re-calibrating the transmitter, verify the absence of gas.

Zero and Span Cal for XNX with MPD / 705 Comb / Sensepoint Comb

⚠ CAUTION

Extended or frequent exposure to elevated concentrations of combustible gases may affect sensor sensitivity. Verify sensor performance by frequent calibration.

Before initial calibration, allow the sensor to stabilize for 30 minutes after applying power. When in Zero and Span Calibration modes, the current output from the sensor is inhibited (default 2mA) to avoid false alarms.

For most sticky gases (e.g., HCl, Cl₂) use PTFE tubing with short pieces of rubber tube for the final connection (due to the inflexibility of PTFE). This minimizes adhesion of the gas to the tube surface and allows more accurate measurement.

To calibrate the sensor, use an appropriate span gas cylinder, tubing, magnet, and calibration gas flow housing. Set the flow regulator to 300-375 ml/min for XNX EC sensors or 500 ±200 ml/min for XNX mV sensors. A compressed gas cylinder (20.9%Vol oxygen) should be used to perform the zero calibration if the area where the sensor is located contains any residual amount of the target gas. If no residual gas is present, background air can be used to perform the zero calibration. Contact a Honeywell Analytics representative for details about suitable calibration kits.

Zero Calibration

The following equipment is required:

- Flow housing (P/N: 1226A0411)
- Test gas
- Regulator

NOTE

Zero gas and Span gas should be at about the same humidity levels to avoid erroneous cell responses

This section outlines the steps for calibrating the transmitter's attached sensors.

NOTE

The Zero Calibration procedure should be performed prior to the Span Calibration procedure.

2. At the MPD, remove the weatherproof cap, if equipped.
3. Fit the flow housing onto the MPD.

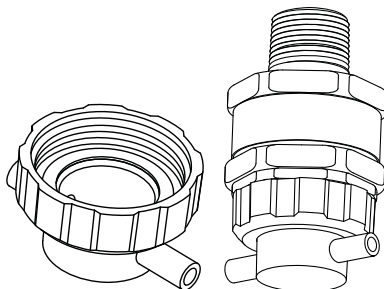

4. Connect the flow housing (using either gas pipe) to the regulated cylinder containing zero gas.
5. Access the Gas Calibration Menu.

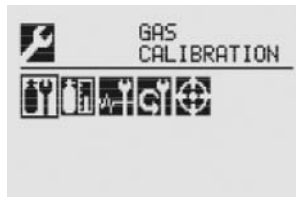

NOTE

The Gas Calibration menu is for both Zero Calibration and Span Calibration.



As the sensor detects the gas and the concentration increases, the values displayed will reflect the changing concentration. When the concentration values are stable, 3 minutes, select to allow the transmitter to calculate the zero adjustment. Selecting will return to the Gas Calibration menu.



6. If the zero calibration is successful, the transmitter will display the Zero Passed screen.

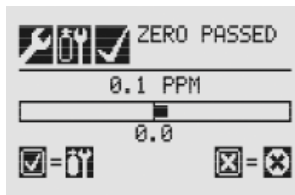

Span Calibration

If a Span Calibration is not required, select the to skip the Span Calibration and return to the Calibration menu.

7. When the Zero Calibration is complete, the Span Concentration screen appears. The gas concentration for the Span Gas Calibration can be changed. If the Span Calibration is skipped, the Gas Calibration screen displays.

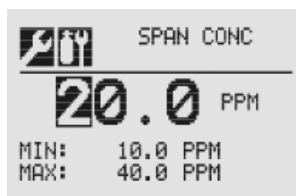

8. Enter the concentration of the span gas by selecting to choose the first digit. Use the switches to increment or decrement the values. Use to accept the new value and move to the next digit. Continue until all digits have been selected.

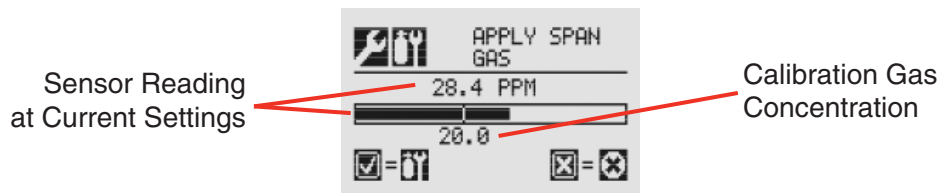



 **WARNING**

As some test gases are hazardous, exhaust the flow housing outlet to a safe area.

9. Apply the span gas. Pass the gas through the flow housing at a rate of 500 ± 200 ml/min for XNX mV sensors. As the sensor detects the gas and the concentration increases, the values displayed will reflect the changing concentration. When the concentration values are stable, select  to perform the span. The Span Calibration process also determines whether the sensor is within the proper range to accurately detect the target gas.

Selecting  will cancel the span calibration and return to the Gas Calibration menu.

10. When the sensor has completed the calibration and the span algorithms have determined that it is within range, the Span Passed screen will appear.

If the calibration is not successful, the Span Failed screen will display. Selecting  will return to the Span Concentration screen to begin the span calibration again. Selecting  will exit Span Calibration and return to the Gas Calibration Menu.

Once the Zero Gas and Span calibrations are completed successfully, the user will be prompted to:

- exit with inhibit off
- exit with inhibit on, or
- not exit.

 **WARNING**

When the XNX transmitter is placed in Inhibit Mode, alarms are silenced. This will prevent an actual gas event from being reported. Inhibit Mode must be limited to testing and maintenance only. Exit Inhibit Mode after testing or maintenance activities.



Calibration Kits and Equipment

Calibration Kits and Equipment

For calibration gas, please contact Honeywell Analytics Customer Service at 800-323-2000.

Regulator Guide		
Product	Description	Flow Rate
XNX - EC	XNX transmitter for use with electrochemical sensors	300 - 375 ml/min
XNX - MPD	XNX transmitter for use with multi-purpose detector	0.5 liter/min
Apex	Apex toxic and combustible gas detector	0.7 - 1.0 liter/min
XCD	Sensepoint XCD - Zero Gas (Air or N2)	0.5 - 1.0 liter/min
XCD	Sensepoint XCD - O2, H2, H2S and CO	0.5 - 1.0 liter/min
XCD	Sensepoint XCD - Flammable Cat	1.0 - 1.5 liter/min
XCD	Sensepoint XCD - Flammable IR	0.4 - 0.6 liter/min
XCD	Sensepoint XCD - IR CO2	0.4 - 0.6 liter/min
XCD RTD	Sensepoint XCD RTD - Remote Toxic	1.0 - 1.5 liter/min
Series 3000	Series 3000 toxic & oxygen sensors	300 - 375 ml/min
705	705 & 705HT Flammable sensors	1.5 liter/min
Sensepoint	Sieger Sensepoint Flammable	1.0 - 1.5 liter/min
Sensepoint	Sieger Sensepoint Toxic	1.0 - 1.5 liter/min
Satellite XT	Satellite XT	0.3 liter/min
Midas	Midas	0.5 liter/min
Optima Plus	Optima Plus w/Remote Gassing Cell	0.3 liter/min
Optima Plus	Optima Plus w/Gassing Cover	2.0 liter/min
Optima Plus	Optima Plus w/Flow Housing	2.0 liter/min
EC-F2	Manning EC-F2	0.75 - 1.0 liter/min
EC-F3	Manning EC-F3 O2 sensor	0.75 - 1.0 liter/min
EC-F9	Manning EC-F9 NH3	0.75 - 1.0 liter/min
IR-F9	Manning IR-F9	0.75 - 1.0 liter/min
E ³ Point	E3Point Toxic and Combustible	0.5 - 1.0 liter/min
GasPoint II	GasPoint II Toxic and Combustible	0.5 - 1.0 liter/min
301IRFS	R-Gas Refrigerant Detector	0.1 liter/min
S301D2	Toxic and Combustible	0.5 liter/min
201T/301T/301M	Toxic and Combustible	0.5 - 1.0 liter/min
301W	Toxic	0.5 - 1.0 liter/min

Calibration Kits, Calibration Components, and Calibration Gas

Part Number	Description
-------------	-------------

Cal kits do not include gas. Gas must be ordered separately and will arrive separately.

XNX Universal Transmitter

XNXTOKIT	XNX Toxic Kit Includes: FEP Tubing (998-100-004 - 5/ft), Flow adaptor (S3KCAL), Regulator (0.3 LPM - ZCALREG1), Carrying case (998-100-003)
XNXCOMBKIT	XNX Combustibles Kit Includes: Tygon Tubing (106459 - 5/ft), Flow adaptor (1226A0411), Demand flow regulator (0.5LPM - N600 1001 33), Carrying case (998-100-003)

Sensepoint XCD

XCDTOXKIT	XCD Toxic Kit* Includes: FEP Tubing (998-100-004 - 5/ft), Flow adaptor (S3KCAL), Regulator (1 LPM - 998-100-015), Carrying case (998-100-003)
-----------	--

* XCDTOXKIT should be used with XCD-Flammable IR

XCDCOMBKIT	XCD Combustibles Kit Includes: FEP Tubing (998-100-004 - 5/ft), Flow adaptor (S3KCAL), Regulator (1.5 LPM - 998-100-012), Carrying case (998-100-003)
------------	--

Sensepoint XCD RTD

	XCD RTD Gassing Cap, Spanner Wrench and Pot Trimmer (2106D2114), Flow Housing (02000-A-1645)
--	--

Searchpoint Optima Plus

OPTIMARGCCALKIT	Remote Gassing Cell (RGC) Includes: FEP Tubing (998-100-004 - 5/ft), Gas cover (2108D0258), Regulator (0.3LPM - ZCALREG1)
OPTIMACALKIT	Non-RGC Includes: FEP Tubing (998-100-004 - 5/ft), Gas cover (2108D0258), Regulator (2LPM - 998-100-002), w/Gas Cell

Searchline Excel

2104N2999	Test filters
-----------	--------------

Series 3000

XNXTOKIT	Includes: FEP Tubing (998-100-004 - 5/ft), Flow adaptor (S3KCAL), Regulator (0.3LPM - ZCALREG1), Carrying case (998-100-003)
----------	--

705

705CALKIT	Includes: FEP Tubing (998-100-004 - 5/ft), Flow adaptor (00780-A-0035), Regulator (1.5LPM - 998-100-012), Carrying case (998-100-003)
-----------	---

Sensepoint

SNSPTCALKIT	Includes: FEP Tubing (0310-2021 - 5/ft), Flow adaptor (02000-A-1645), Regulator (1.5LPM - 998-100-012), Carrying case (998-100-003)
-------------	---

Apex

APEXCALKIT	Includes: FEP Tubing (998-100-004), Flow adaptor (2110B2140), Regulator (1LPM - 998-100-015), Carrying case (998-100-003)
------------	---

Calibration Kits, Calibration Components, and Calibration Gas

EC-F2

11252-L9	For 17L/34L Cylinders Includes: Calibration Adapter w/Tubing and Tee (10244), Regulator (1LPM - 10687-L9), Carrying Case
11253-L9	For 29L Cylinders Includes: Calibration Adapter w/Tubing and Tee (10244), Regulator (1LPM - 10597-L9), Carrying Case
11337-L9	For 58L/103L Cylinders Includes: Calibration Adapter w/Tubing and Tee (10244), Regulator (1LPM - 10597-L9), Carrying Case

EC-F3

11252-L9	For 17L/34L Cylinders Includes: Calibration Adapter w/Tubing and Tee (10244), Regulator (1LPM - 10687-L9), Carrying Case
11253-L9	For 29L Cylinders Includes: Calibration Adapter w/Tubing and Tee (10244), Regulator (1LPM - 10597-L9), Carrying Case
11337-L9	For 58L/103L Cylinders Includes: Calibration Adapter w/Tubing and Tee (10244), Regulator (1LPM - 10597-L9), Carrying Case

EC-F9

11252-L9	For 17L/34L Cylinders Includes: Calibration Adapter w/Tubing and Tee (10244), Regulator (1LPM - 10687-L9), Carrying Case
11253-L9	For 29L Cylinders Includes: Calibration Adapter w/Tubing and Tee (10244), Regulator (1LPM - 10597-L9), Carrying Case
11337-L9	For 58L/103L Cylinders Includes: Calibration Adapter w/Tubing and Tee (10244), Regulator (1LPM - 10597-L9), Carrying Case

IR-F9

11252-L9	For 17L/34L Cylinders Includes: Calibration Adapter w/Tubing and Tee (10244), Regulator (1LPM - 10687-L9), Carrying Case
11253-L9	For 29L Cylinders Includes: Calibration Adapter w/Tubing and Tee (10244), Regulator (1LPM - 10597-L9), Carrying Case
11337-L9	For 58L/103L Cylinders Includes: Calibration Adapter w/Tubing and Tee (10244), Regulator (1LPM - 10597-L9), Carrying Case

E³Point

1309K0002	For 17L/34L Cylinders Includes: Tubing (M-508808 - 1/8 ID x 1/4 OD x 6ft), Polyurethane Tubing (M-502730 - 4mm ID x 6mm OD), Magnet for GasPoint II (M-502499), Calibration Adapter for IAQPoint (M-512438), Calibration Port for 201T/201M/301M/GasPoint II (M-501080), Calibration Adapter for E ³ Point and 301W (131635-L3), Calibration Adapter for ToxyPoint (M-505490), Calibration Adapter for EC-F9 (M-507527), Regulator (0.1LPM - M-505425), Regulator (0.5LPM - M-502877), Carrying case (M-501056)
1309K0004	For 58L/103L Cylinders Includes: Tubing (M-508808 - 1/8 ID x 1/4 OD x 6ft), Polyurethane Tubing (M-502730 - 4mm ID x 6mm OD), Magnet for GasPoint II (M-502499), Calibration Adapter for IAQPoint (M-512438), Calibration Port for 201T/201M/301M/GasPoint II (M-501080), Calibration Adapter for E ³ Point and 301W (131635-L3), Calibration Adapter for ToxyPoint (M-505490), Calibration Adapter for EC-F9 (M-507527), Regulator (0.1LPM - M-502874), Regulator (0.5LPM - M-502875), Carrying case (M-501057)

Calibration Kits, Calibration Components, and Calibration Gas

301W

1309K0002	For 17L/34L Cylinders Includes: Tubing (M-508808 - 1/8 ID x 1/4 OD x 6ft), Polyurethane Tubing (M-502730 - 4mm ID x 6mm OD), Magnet for GasPoint II (M-502499), Calibration Adapter for IAQPoint (M-512438), Calibration Port for 201T/201M/301M/GasPoint II (M-501080), Calibration Adapter for E ³ Point and 301W (131635-L3), Calibration Adapter for ToxyPoint (M-505490), Calibration Adapter for EC-F9 (M-507527), Regulator (0.1LPM - M-505425), Regulator (0.5LPM - M-502877), Carrying case (M-501056)
1309K0004	For 58L/103L Cylinders Includes: Tubing (M-508808 - 1/8 ID x 1/4 OD x 6ft), Polyurethane Tubing (M-502730 - 4mm ID x 6mm OD), Magnet for GasPoint II (M-502499), Calibration Adapter for IAQPoint (M-512438), Calibration Port for 201T/201M/301M/GasPoint II (M-501080), Calibration Adapter for E ³ Point and 301W (131635-L3), Calibration Adapter for ToxyPoint (M-505490), Calibration Adapter for EC-F9 (M-507527), Regulator (0.1LPM - M-502874), Regulator (0.5LPM - M-502875), Carrying case (M-501057)

GasPoint II / VA301D2

1309K0002	For 17L/34L Cylinders Includes: Tubing (M-508808 - 1/8 ID x 1/4 OD x 6ft), Polyurethane Tubing (M-502730 - 4mm ID x 6mm OD), Magnet for GasPoint II (M-502499), Calibration Adapter for IAQPoint (M-512438), Calibration Port for 201T/201M/301M/GasPoint II (M-501080), Calibration Adapter for E ³ Point and 301W (131635-L3), Calibration Adapter for ToxyPoint (M-505490), Calibration Adapter for EC-F9 (M-507527), Regulator (0.1LPM - M-505425), Regulator (0.5LPM - M-502877), Carrying case (M-501056)
1309K0004	For 58L/103L Cylinders Includes: Tubing (M-508808 - 1/8 ID x 1/4 OD x 6ft), Polyurethane Tubing (M-502730 - 4mm ID x 6mm OD), Magnet for GasPoint II (M-502499), Calibration Adapter for IAQPoint (M-512438), Calibration Port for 201T/201M/301M/GasPoint II (M-501080), Calibration Adapter for E ³ Point and 301W (131635-L3), Calibration Adapter for ToxyPoint (M-505490), Calibration Adapter for EC-F9 (M-507527), Regulator (0.1LPM - M-502874), Regulator (0.5LPM - M-502875), Carrying case (M-501057)

301IRFS / S301D2 with 301EM

1309K0002	For 17L/34L Cylinders Includes: Tubing (M-508808 - 1/8 ID x 1/4 OD x 6ft), Polyurethane Tubing (M-502730 - 4mm ID x 6mm OD), Magnet for GasPoint II (M-502499), Calibration Adapter for IAQPoint (M-512438), Calibration Port for 201T/201M/301M/GasPoint II (M-501080), Calibration Adapter for E ³ Point and 301W (131635-L3), Calibration Adapter for ToxyPoint (M-505490), Calibration Adapter for EC-F9 (M-507527), Regulator (0.1LPM - M-505425), Regulator (0.5LPM - M-502877), Carrying case (M-501056)
1309K0004	For 58L/103L Cylinders Includes: Tubing (M-508808 - 1/8 ID x 1/4 OD x 6ft), Polyurethane Tubing (M-502730 - 4mm ID x 6mm OD), Magnet for GasPoint II (M-502499), Calibration Adapter for IAQPoint (M-512438), Calibration Port for 201T/201M/301M/GasPoint II (M-501080), Calibration Adapter for E ³ Point and 301W (131635-L3), Calibration Adapter for ToxyPoint (M-505490), Calibration Adapter for EC-F9 (M-507527), Regulator (0.1LPM - M-502874), Regulator (0.5LPM - M-502875), Carrying case (M-501057)

Calibration Kits, Calibration Components, and Calibration Gas

IAQPoint

1309K0002	For 17L/34L Cylinders Includes: Tubing (M-508808 - 1/8 ID x 1/4 OD x 6ft), Polyurethane Tubing (M-502730 - 4mm ID x 6mm OD), Magnet for GasPoint II (M-502499), Calibration Adapter for IAQPoint (M-512438), Calibration Port for 201T/201M/301M/GasPoint II (M-501080), Calibration Adapter for E ³ Point and 301W (131635-L3), Calibration Adapter for ToxyPoint (M-505490), Calibration Adapter for EC-F9 (M-507527), Regulator (0.1LPM - M-505425), Regulator (0.5LPM - M-502877), Carrying case (M-501056)
-----------	--

1309K0004	For 58L/103L Cylinders Includes: Tubing (M-508808 - 1/8 ID x 1/4 OD x 6ft), Polyurethane Tubing (M-502730 - 4mm ID x 6mm OD), Magnet for GasPoint II (M-502499), Calibration Adapter for IAQPoint (M-512438), Calibration Port for 201T/201M/301M/GasPoint II (M-501080), Calibration Adapter for E ³ Point and 301W (131635-L3), Calibration Adapter for ToxyPoint (M-505490), Calibration Adapter for EC-F9 (M-507527), Regulator (0.1LPM - M-502874), Regulator (0.5LPM - M-502875), Carrying case (M-501057)
-----------	---

SQN8x

M-700144	Regulator 58-103L Cylinders, 0-3LPM
----------	-------------------------------------

M-700145	Regulator 17-34L Cylinders, 0-3LPM
----------	------------------------------------

M-501062	Tubing 1/8 ID X 1/4 OD x 6ft
----------	------------------------------

Sensepoint Toxic

2106D2907	Calibration Cap
-----------	-----------------

705 Toxic

00780-A-0035	Calibration Cap
--------------	-----------------

MPD

1226A0411	Calibration Cap
-----------	-----------------

Find out more

www.honeywellanalytics.com

Americas

Honeywell Analytics
405 Barclay Boulevard
Lincolnshire, IL 60069
Tel: +1 847 955 8200
Toll free: +1 800 538 0363
Fax: +1 847 955 8208
detectgas@honeywell.com

Europe, Middle East, and Africa

Life Safety Distribution AG
Wilstrasse 11-U11
CH-8610 Uster
Switzerland
Tel: +41 (0)1 943 4300
Fax: +41 (0)1 943 4398
gasdetection@honeywell.com

Technical Services

ha.global.service@honeywell.com

www.honeywell.com

Asia Pacific

Honeywell Analytics
#508, Kolon Science Valley (I)
187-10 Guro-Dong, Guro-Gu
Seoul, 152-050 Korea
Tel: +82 2 2025 0300
Fax: +82 2 2025 0329
analytics.ap@honeywell.com

Please Note:

While every effort has been made to ensure accuracy in this publication, no responsibility can be accepted for errors or omissions.
Data may change, as well as legislation, and you are strongly advised to obtain copies of the most recently issued regulations, standards and guidelines.
This publication is not intended to form the basis of a contract.

Honeywell