



PREMIUM POLYCARBONATE ENCLOSURE

Features and Benefits

- 16 Standard configurations including hinged or non-hinged lids in 2-screw, 4-screw, or stainless steel metal latched lids.
- Standard color – light gray with a gloss finish.
- Best material – bases, opaque covers and clear covers are all made of high-impact, UV resistant polycarbonate.
- Easy ordering – one part number includes base, lid, mounting feet or flanges and all lid fastening hardware (mounting panels sold separately).
- Flexible interior mounting – features the unique and patented Integra adjustable depth “T-Rail” back panel mounting system (back panel and adjustable brackets sold separately).
- Features multiple bosses for easy installation of devices and DIN rails.
- UL-50 / c-UL Listed (files # E229365, # E207562)

Our Premium Line enclosures are the most durable, aesthetically pleasing, non-metallic Nema UL rated enclosures available. From the extremely versatile mounting options inside the enclosure to having the most off-the-shelf accessories, the Integra “Made In the USA” Premium Line enclosures provide great value to any application.

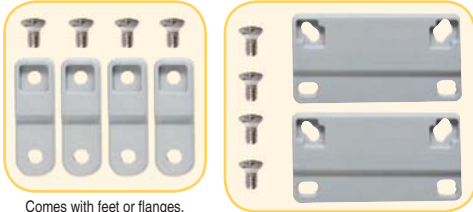

Comes with feet or flanges.



Atex pending, contact factory for details

Mechanical and Thermal	Test Spec.	Unit	Premium Line
Instrumented Dart Impact @ 73° F		in/lb.	565
Falling Ball Impact @ 73° F	UL-746	in/lb.	900
Deflection Temperature @ 264 psi	ASTM D648	Deg. F	270
Modulus of Elasticity	ASTM D790	ksi	340
Temperature Range		Deg. F	-40 to 265
Flammable / UV Ratings	Test Spec.	Unit	Premium Line
Flame Rating - UL	UL 94	-	5VA
Outdoor UV Exposure	UL	-	F1

6064 P/N	4X IP66	6P IP68	Hinged Cover	Screw Cover	Opaque Cover	Clear Cover	Mounting Feet	Mounting Flange	Stainless Steel Locking Latch	T-Rail System
H6064S	✓	✓		✓	✓		✓			✓
H6064SC	✓	✓		✓		✓	✓			✓
H6064SF	✓	✓		✓	✓			✓		✓
H6064SCF	✓	✓		✓		✓		✓		✓
H6064H	✓		✓	✓	✓		✓			✓
H6064HC	✓		✓	✓		✓	✓			✓
H6064HF	✓		✓	✓	✓			✓		✓
H6064HCF	✓		✓	✓		✓		✓		✓
H6064HLL	✓		✓		✓		✓		✓	✓
H6064HCLL	✓		✓			✓	✓		✓	✓
H6064HFLL	✓		✓		✓			✓	✓	✓
H6064HCFLL	✓		✓			✓		✓	✓	✓
H6064H-6P	✓	✓	✓	✓	✓		✓			✓
H6064HC-6P	✓	✓	✓	✓		✓	✓			✓
H6064HF-6P	✓	✓	✓	✓	✓			✓		✓
H6064HCF-6P	✓	✓	✓	✓		✓		✓		✓

TORQUE SPECIFICATIONS - Mounting Brackets - 1/4"-20 x 0.25 SS, countersunk phillips drive screws (torque limit = 20 in. lbs.) | Covers / Doors - Torque for corner screws is 10 in. lbs.





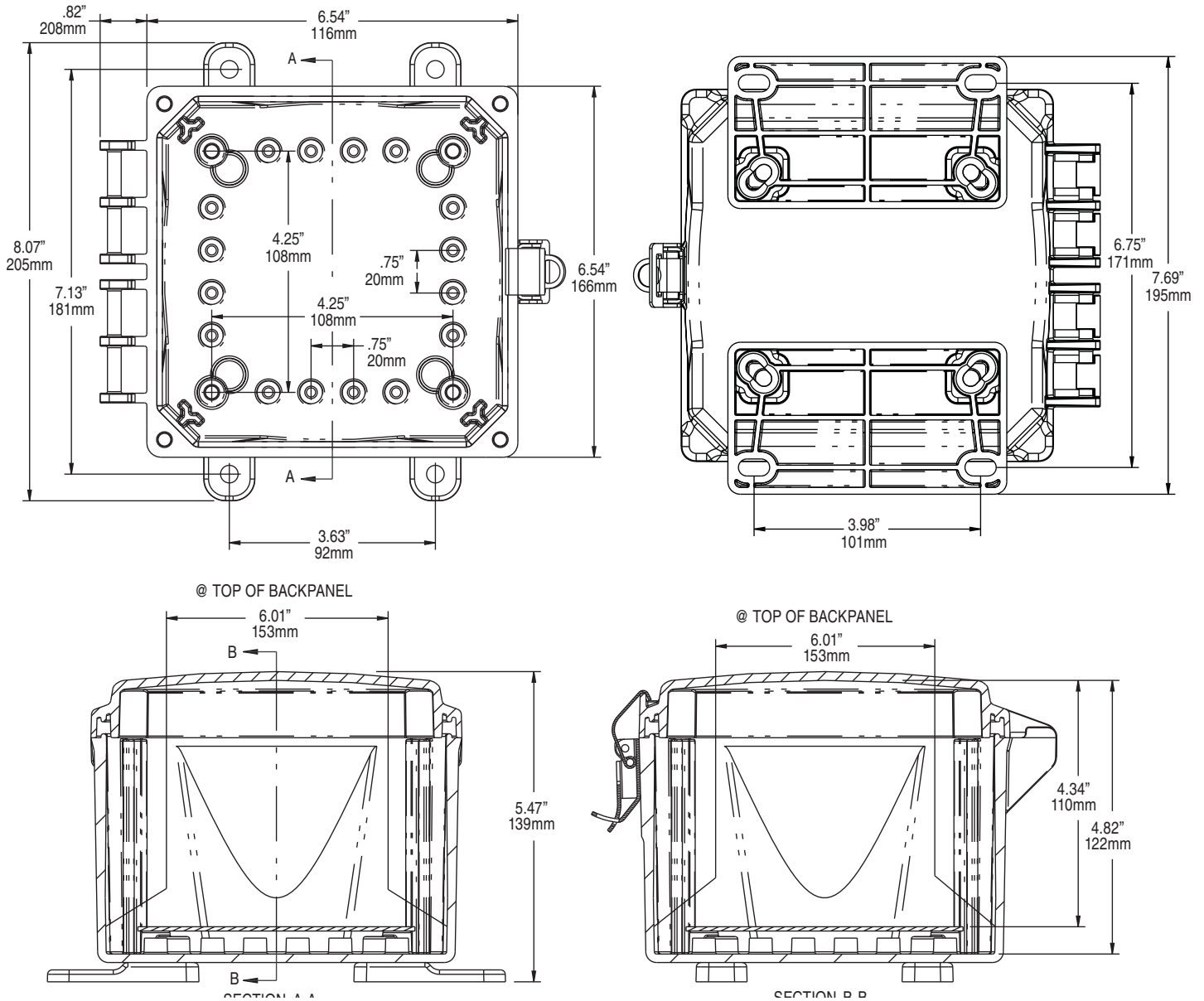





6X6X4 PREMIUM LINE



Register online to download this drawing off the Integra website at www.integraenclosures.com | Your company's logo or other information on the lid. Consult factory for details.

Accessories for 6x6x4 (For complete accessories, see page 49-52)

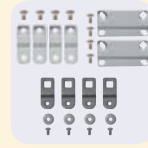
 <p>Back Panels ABP66 - Aluminum panel SBP66 - Steel panel PVCBP66 - PVC panel</p>	 <p>Aluminum Swing Out Panels ABP-66USP/USOPK - Complete panel kit ABP-66USP - Aluminum swing out panels only USOPK - Hardware only</p>	 <p>Back Panel Adjustment Kit BPAKG - Gray, Set Screw BPAKB - Black, Set Screw UBPAKG - Gray, Thumb Screw UBPAKB - Black Thumb Screw</p>
 <p>Air Vents VENT 1 - Aluminum louvered VENT 2 - Outdoor labyrinth</p>	 <p>Steel Swing Out Panels SBP-66USP/USOPK - Complete panel kit SBP-66USP - Steel swing out panels only USOPK - Hardware only</p>	 <p>Cord Grips IP68/NEMA 4X/6P rated See page 54 for more details and part numbers.</p>
 <p>Din Rail DIN 6 - 2 rails, 4 screws</p>	 <p>Pole Mounting Kit PMKG-26 - 2" pole PMKG-36 - 3" pole PMKG-46 - 4" pole PMKG-126 - 12" pole</p>	 <p>Mounting Feet & Flange Kits MFKG - Premium line feet MFKSS - Stainless steel feet MFLK6 - 6" Flange kit</p>