

SAV Electronic Valve Actuator

Non-spring Return, 24 Vac/dc, 3-Position Control



Description	The SAV Non-spring Return (NSR), Electronic Valve Actuator requires a 24 Vac/dc supply to provide three-position (floating) control of a valve. This actuator is designed to work with Siemens flanged, Pressure Independent Control Valves with a 1-1/2-inch (40 mm) stroke.
Features	<ul style="list-style-type: none">• 24 Vac/Vdc operating voltage• Direct-coupled installation requires no special tools or adjustments• Visual stroke indication• Manual override• Overload and stall protection• Optional functions with auxiliary switches, potentiometer, and stem heater• Maintenance-free
Application	<p>These electronic actuators are designed to be used with Siemens flanged, Pressure Independent Control valves with 1-1/2-inch (40 mm) stroke in hot and chilled water applications in closed loop HVAC systems.</p> <p>NOTE: Consult Technical Support if using with a TEC.</p>
Product Number	SAV81.00U (Actuator Prefix Code 379)

Specifications	Operating voltage	24 Vac \pm 20% 24 Vdc + 20%/-15%, Class 2
	Power supply	Frequency Fusing of supply lines Power consumption Stem retracts/extends
		45 to 65 Hz Max. 10A slow 7 VA/4.5 W
Function data	Positioning times	120 s
	Positioning force	360 lb (1600 N)
	Nominal stroke	1-1/2-inch (40 mm)
	Permissible medium temperature (valve fitted)	34°F to 248°F (1°C to 120°C)
Signal inputs	Positioning signals "Y1", "Y2"	3-position
	Voltage	24 Vac \pm 20%/24 Vdc + 20%/-15%
Connecting cable	Wire gauge	16 to 24 AWG
	Cable entries	3 entries for 1/2" conduit connection
Degree of protection	Housing from vertical to horizontal	IP54, as per EN 60529
	With Weathershield ASK39.1	NEMA 3R
	Insulation class for 24 Vac/Vdc	Class III, as per EN 60730
Environmental conditions	Operation	IEC 60721-3-3
	Climatic conditions	Class 3K5
	Mounting location	Indoors (weather-protected)
	Ambient temperature	23°F to 131°F (-5°C to 55°C)
	Humidity (non-condensing)	5 to 95% rh
	Transportation	IEC 60721-3-2
	Climatic conditions	Class 2K3
	Temperature	-13°F to 158°F (-25°C to 70°C)
	Humidity	< 95% rh
	Storage	IEC 60721-3-1
Temperature	5°F to 131°F (-15°C to 55°C)	
Humidity	5 to 95% rh	
	Max. media temperature when mounted on a valve	248°F (120°C)
Environmental compatibility		ISO 14001 (environment)
		ISO 9001 (quality)
		SN36350 (environment-compatible products)
		RL 2002/95/EG (RoHS)
Standards	CE conformity	2014/30/EU
	As per EMC directive	EN 61000-6-2:[2005] Industrial
	Immunity	EN 61000-6-3:[2007] Residential
	Emissions	
	Australia	RCM
	UL	UL 873
C-UL	Canadian standard C22.2 No. 24	

Specifications (Continued)	Potentiometer ASZ7.5/135	0 to 135 $\Omega \pm 5\%$
	Voltage	10 Vdc
	Current rating	<4 mA
Accessories	Potentiometer ASZ7.5/200	0 to 200 $\Omega \pm 5\%$
	Voltage	10 Vdc
	Current rating	<4 mA
	Potentiometer ASZ7.5/1000	0 to 1,000 $\Omega \pm 5\%$
	Voltage	10 Vdc
	Current rating	<4 mA
	Auxiliary switch ASC10.51	
	Switching capacity	24 to 230V, 6A res., 2A Ind.
	Stem heating element ASZ6.6	
	Power consumption	24 Vac/dc 40 VA/30W

Accessories

NOTE: Installation instructions are included with each accessory.

Product Number	Auxiliary Switch ASC10.51	Potentiometer ASZ7.5/.. ¹⁾	Stem Heating Element ASZ6.6
SAV81.00U	Max. 2	Max. 1	Max. 1

1) Available with 135 Ω , 200 Ω , or 1000 Ω .

**Auxiliary Switch
ASC10.51**

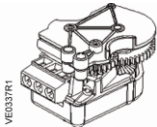

Auxiliary switch ASC10.51 switches on or off when a certain position is reached. The switching point can lie between 0 to 100%.

**Potentiometer
ASZ7.5/..**

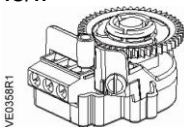

Potentiometer ASZ7.5/.. (1000 Ω , 200 Ω , 135 Ω) delivers an ohmic value to the controller giving the exact position of the actuator (continuous position feedback).

**Stem Heating Element
ASZ6.6**

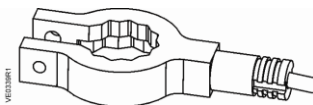

Stem heating element ASZ6.6 prevents the formation of ice on the stem when the medium temperature drops below 32°F (0°C). It is suited for universal use with valves having a stem or spindle diameter of 10 or 14 mm.

**Weather Shield
ASK39.1**

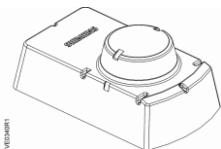

Weather Shield ASK39.1 protects the actuator when installed outdoors. Provides NEMA 3R protection.

Components

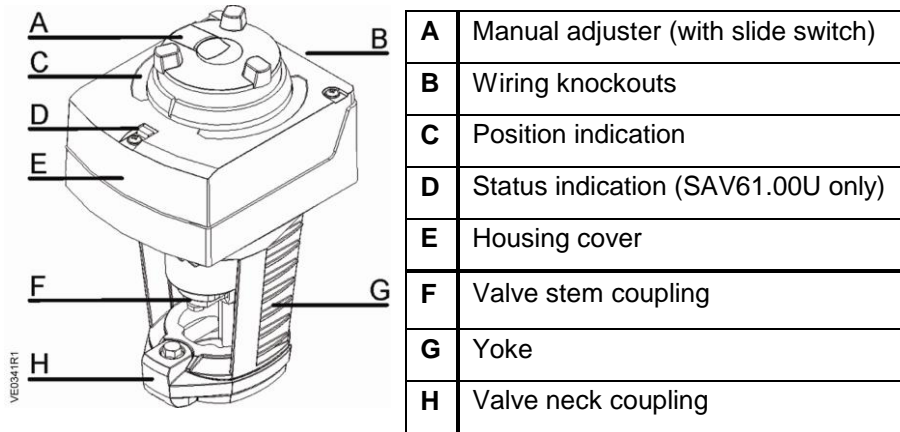

Operation

The actuator accepts a 24 Vac/dc control signal to Y1, which causes the actuator's stem retainer to move toward the valve (extend). A 24 Vac/dc control signal to Y2 causes the actuator's stem retainer to move toward the actuator (retract). The stroke travel is proportional to the length of time the signal is applied.

When power is turned off or in the event of a power failure, the actuator maintains its position.

In the 3-position (floating) actuators, deviation occurs (See Figure 1):

- after several positioning signals Y1 and Y2 in the same direction since the stroke movement starts with a delay of 300 ms.
- when positioning signals Y1 and Y2 are active for less than 300 ms, there is no stroke movement.
- Accurate position feedback is made possible with the help of a potentiometer.

NOTE: Consult Technical Support if using with a TEC.

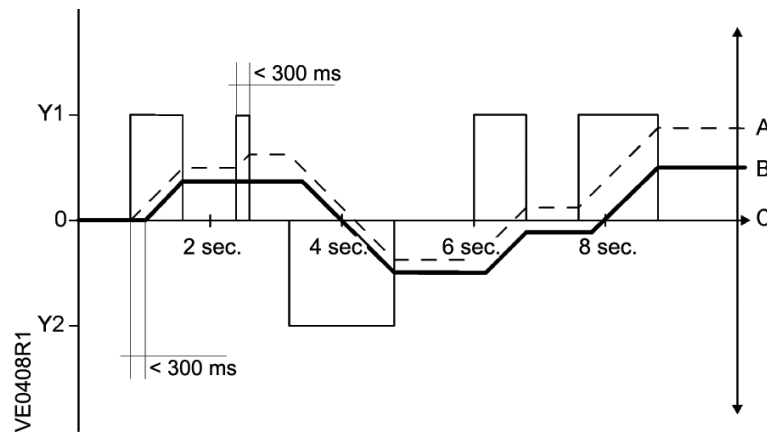

A	B	C	Y1	Y2	0
Calculated position	Actual position	Positioning time [ms]	Positioning signals (power applied)		No power applied

Figure 1. Three-position (Floating) Actuator Deviation.

Manual Override

Automatic mode

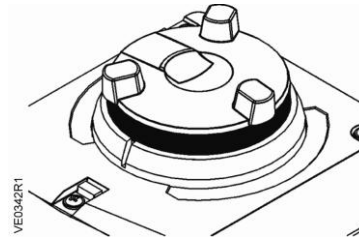

When the motor drives the manual adjuster turns. In Automatic Mode, the manual adjuster is used for indication of travel. If the manual adjuster is held firm in this mode, there is no transmission of power to the gear train.

Manual operation

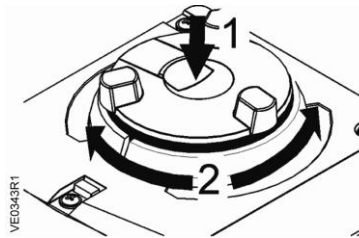

When pushing the manual adjuster down (1), it engages and the actuator can be manually operated.

When turning the manual adjuster in a clockwise/counterclockwise direction (2), the actuator's stem extends/retracts.

An overload protection prevents damage to the manual adjuster.

Setting the position

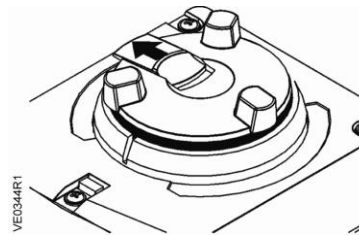

When the black slide switch is pushed out, the manual adjuster remains engaged.

When in this mode, do not turn the manual adjuster.

Disengaging the setting

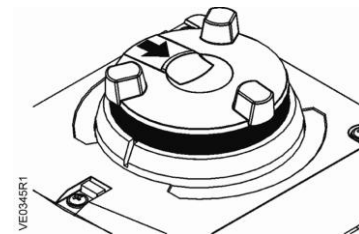

When the black slide switch is pushed back in, and the manual adjuster is not pressed down, the manual adjuster returns to Automatic Mode.

Mounting and Installation

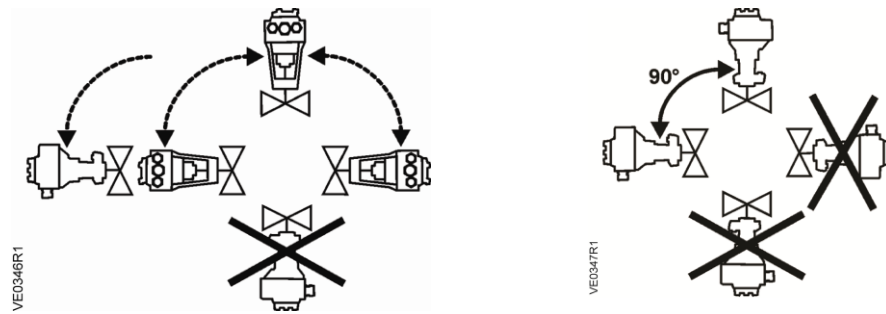

Indoor Use

Outdoor Use¹

1) Only in connection with Weather Shield ASK39.1 for NEMA 3R protection.

Figure 2. Acceptable Mounting Positions.

The vertical position is the recommended position for mounting. Figure 2 shows the acceptable mounting positions.

Allow 8 inches (200 mm) above and on the wiring side of the actuator, and four inches (100 mm) on all other sides of the actuator. This service envelope is the minimum space required to access and service the actuator. See *Dimensions* for actuator dimensions and the recommended service envelope.



CAUTION:

Do not rotate the actuator on the valve once the actuator and valve stem are connected. Doing so will inadvertently adjust the flow setting of the valve.

Start-Up

Check the wiring for proper connections.

PIC Valve

Y1 control signal extends the actuator (0 to 1): Valve closes.
 Y2 control signal retracts the actuator (1 to 0): Valve opens.

Wiring

NOTE: All wiring must conform to national and local codes and regulations (NEC, CE, and so on).

Do not use auto transformers. Use earth ground isolating step-down Class 2 power supplies.

3-position actuators must have one specific controller each. It is not possible to have multiple 3-position actuators in parallel from one controller.

Wiring Diagrams

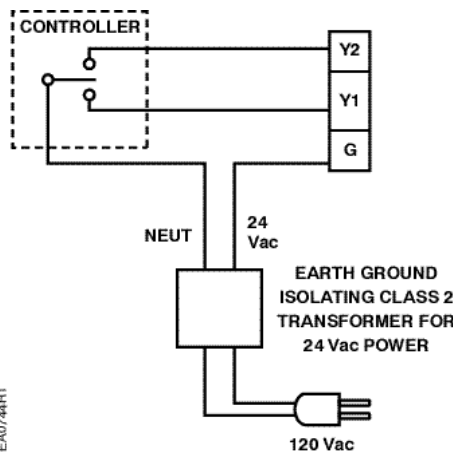

Figure 3.

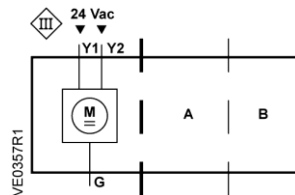
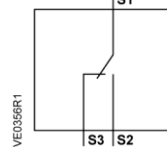

Figure 4. Wiring Designations.

Accessories

A and/or B

1x ASC10.51
 Auxiliary Switch
 24 Vac to 230V / 6 (3) A



or 1 x ASZ7.5/..
 Potentiometer

SELV/PELV 1000 Ω
 0 200 Ω
 0 135 Ω

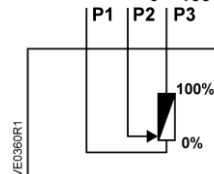

1x ASC10.51
 Auxiliary Switch
 24 Vac to 230V / 6 (3) A

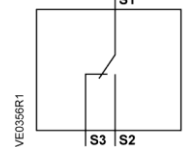

The diagram shows all possible connections. The application determines which connections are used.

Wiring Terminals

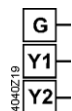

24 Vac/Vdc, 3-Position

System potential (SP)

Positioning signal (actuator's stem extends)

Positioning signal (actuator's stem retracts)

Troubleshooting

Check that the wires are connected correctly and attached securely.

Check for adequate power supply.

Dimensions

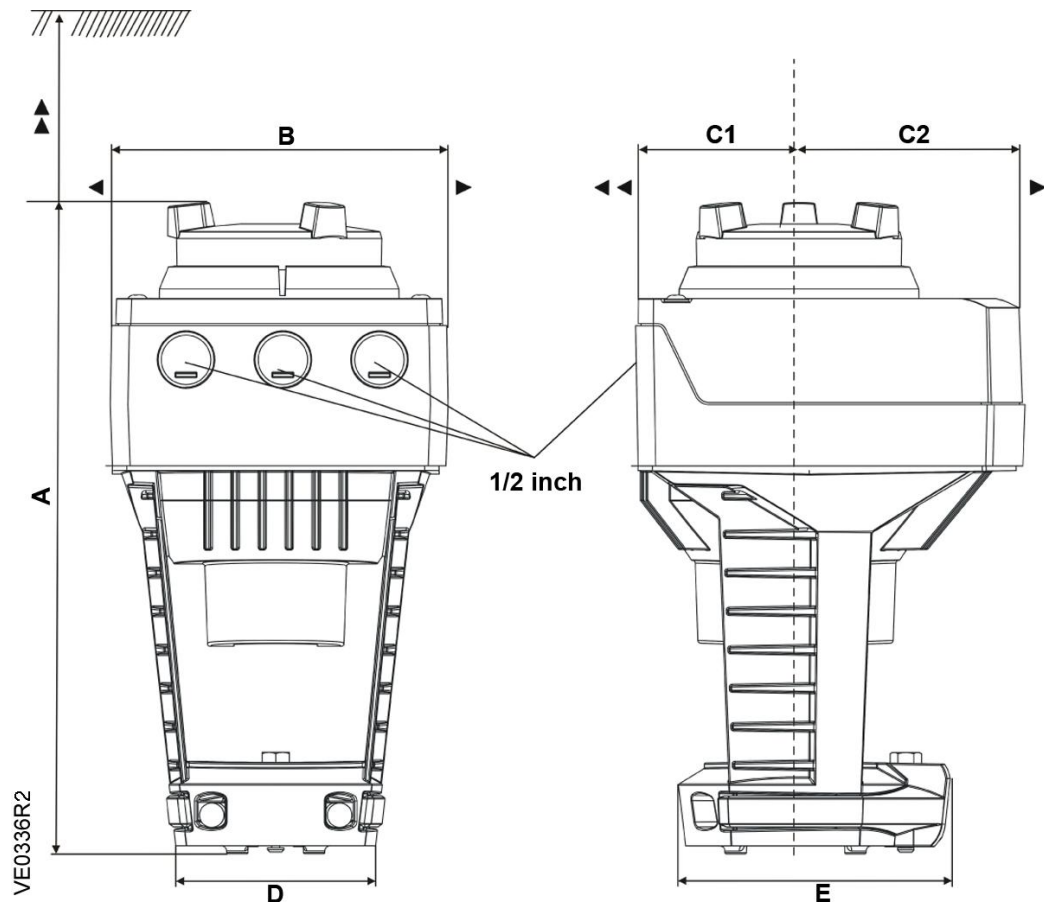
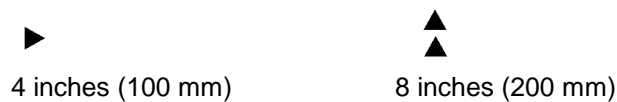

Figure 5. Dimensions in Inches (Millimeters).

Service envelope

Minimum access space recommended



Product Numbers	A	B	C	C1	C2	D	E	▶	▶▶	Weight lbs (kg)
SAV81.03U	10.43 (265)	4.88 (124)	5.91 (150)	2.68 (68)	3.23 (82)	3.15 (80)	3.94 (100)	3.94 (100)	7.87 (200)	4.23 (1.92)
With ASK39.1	11.42 (290)	6.06 (154)	11.81 (300)	7.87 (200)	3.94 (100)	—	—	—	—	4.74 (2.15)

Information in this publication is based on current specifications. The company reserves the right to make changes in specifications and models as design improvements are introduced. Product or company names mentioned herein may be the trademarks of their respective owners.
 © 2016 Siemens Industry, Inc.